

Remanufacturing

The Liebherr Reman Program

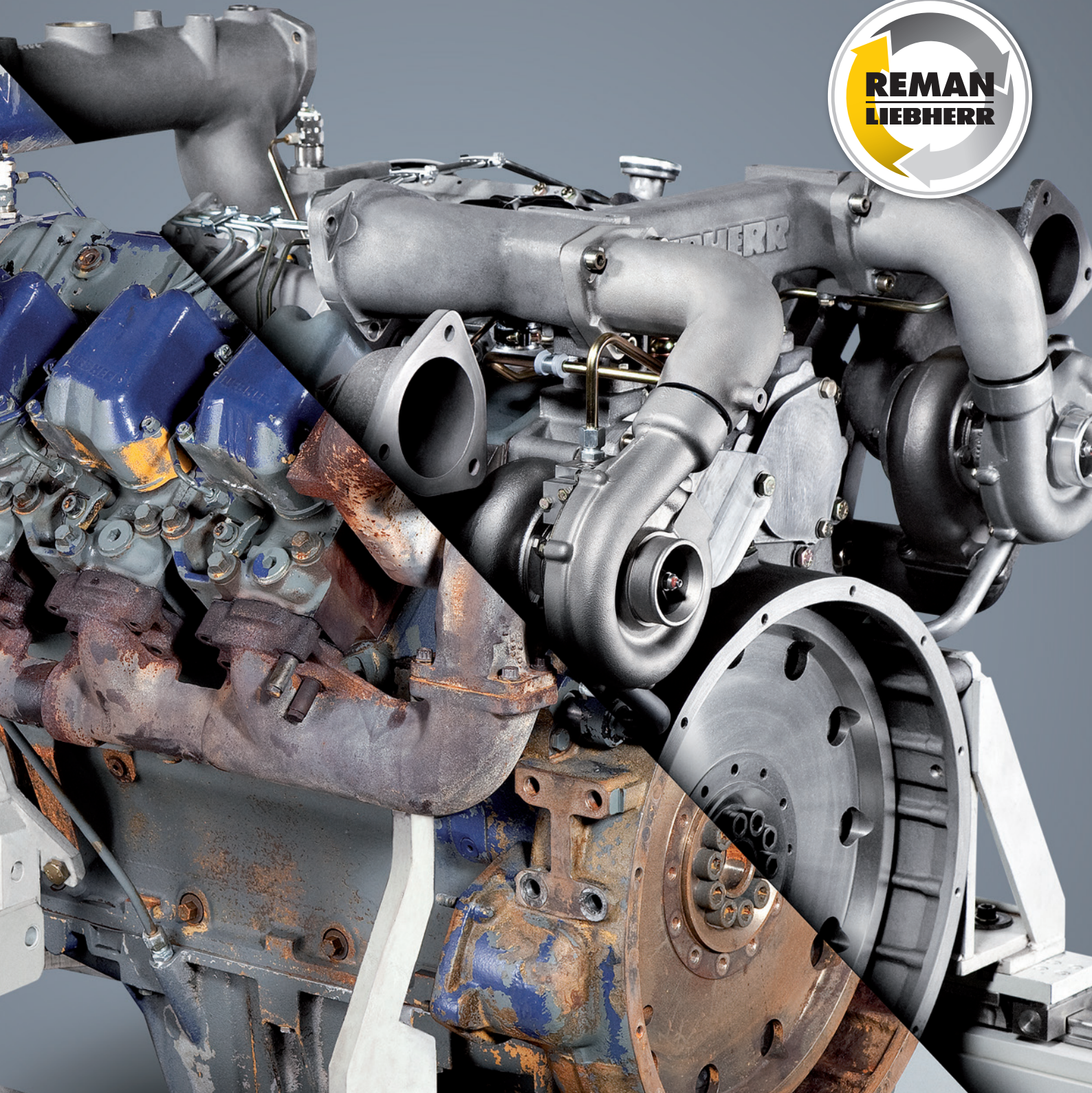

LIEBHERR

Reman components - Maximum customer value

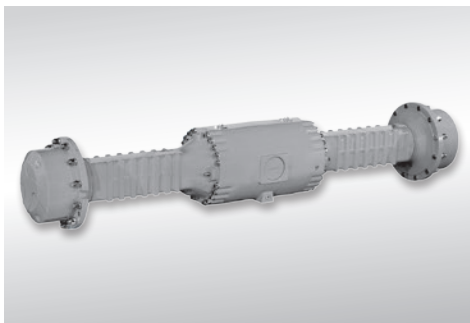

Planetary gear axle



Hydraulic cylinder

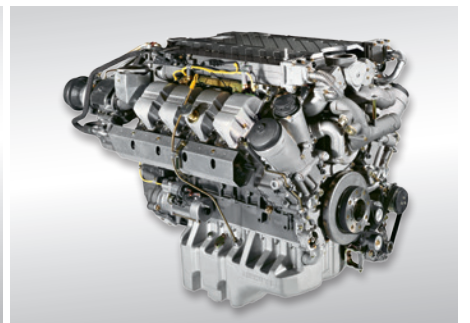

Diesel engine

The cost-effective alternative to new components: Remanufactured components from Liebherr are an intelligent investment for earth moving and material handling machinery, mobile cranes, as well as mining and maritime equipment. Your Liebherr service partner can provide details about the comprehensive Reman Program from Liebherr.

Cost effectiveness

Due to the high exchange value offered for used parts, Reman components ensure the highest level of quality at a significantly lower price than new parts, as well as faster machine availability than time-intensive component repairs by third-party workshops. In this way, Liebherr offers the most economical solution for any customer requirement. Using Reman components reduces the total cost of ownership and increases the service life of a machine.

Liebherr quality

When remanufacturing components Liebherr uses only original parts. OEM know-how and state-of-the-art test benches also help to ensure optimal quality and reliability. The result is a comprehensive guarantee on the complete remanufactured component.

Fast availability

Minimising machine downtime is a top priority made possible by Liebherr's sophisticated logistics and outstanding delivery performance. Exchange Components offer customers unparalleled availability, significantly reducing the length of both scheduled and unscheduled downtime.

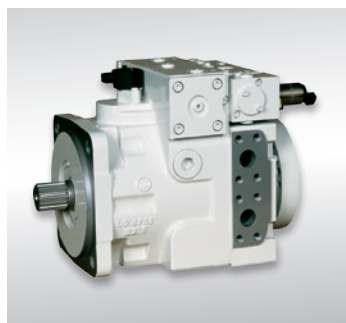

Hydraulic pumps



Splitter box



Swivelling drive



Compact rope winch

The Reman Program

Remanufacturing cycles

V6 engine

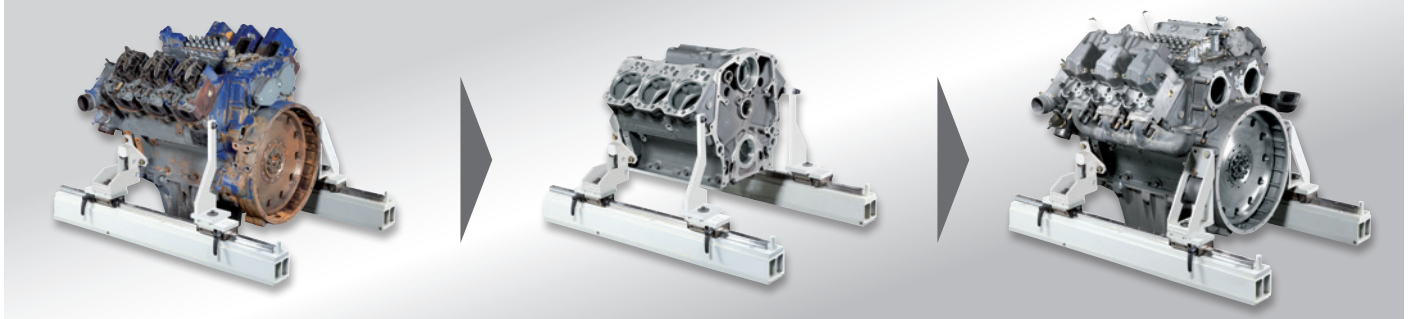

Travel drive

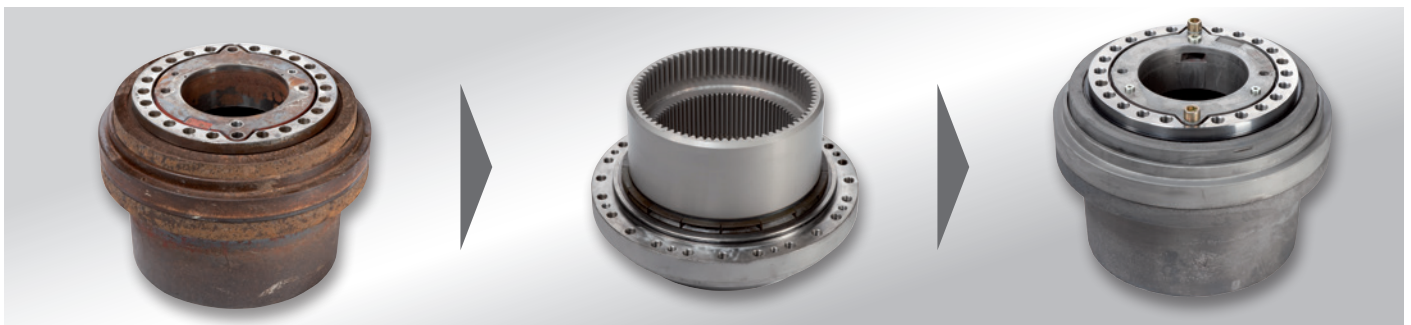

Hydraulic double motor



The most economical solution for every requirement

Regardless of machine maintenance strategy, Liebherr offers customers the most economical solution for all requirements.

Exchange Components

Exchange components are remanufactured to provide the same level of reliability, performance and service life as a new component. With Exchange Components customers can count on the complete Liebherr guarantee.

Liebherr quality

To ensure the usual high level of quality that Liebherr is known for, only original Liebherr parts are used in the remanufacturing process. Naturally, each Exchange Component comes with the full Liebherr guarantee.

Fast availability

With optimal logistics and 98 % parts availability, Liebherr has laid the foundations for the fast delivery and efficient exchange for all Reman components.

Cost effectiveness

Due to the high exchange value offered for used components (core credit), Exchange Components offer a considerable price advantage relative to new components.

General Overhaul

With a General Overhaul, customers' own components are re-conditioned to the original engineering specification. Dimensions, tolerances and performance meet the same high levels of quality as that of the respective new part from Liebherr. A General Overhaul at the European Reman facility takes on average 3-5 days, not including transportation time. All wear parts are replaced with original parts.

Comprehensive guarantee

All General Overhaul components come with the same guarantee as new Liebherr components.

Cost effectiveness

For a General Overhaul customers pay a very competitive fixed price that is up to 50 % below the price of a new component.

Repair Components

The Liebherr Reman Program also includes repaired components. Repair Components come with up to 50 % of the new part guarantee. The repair time is dependent on the extent of damage to be repaired and the amount of work required.

	Exchange Components	General Overhaul	Repair Components
Components for customer	Exchange	Customer's property	Customer's property
Machine downtime	Max. 1 day (installation and removal – with proactive ordering)	5 days (plus transport time)	3 days after order is placed (plus transport time)*
Cost of repair	Fixed price	Fixed price	Offer
Disassembly and cleaning	Complete	Complete	Partial
Paint removal and derusting	Complete	As required	Partial
Assembly	Complete (based on current state of technology)	Complete (based on current state of technology or original condition)	Defective parts replaced with Reman grade or new parts
Inspection	As per OEM standard	As per OEM standard	As per OEM standard
Painting	Complete	Complete	Based on customer requirement
Warranty on complete component	As per new part	As per new part	Up to 50 % of new part

*applies to the Reman Competence Centre in Europe

Cost effectiveness



Liebherr Reman components

Repair by third-party workshops

Basic strip-and-quote repair	•	•
Guaranteed use of only genuine Liebherr parts	•	
Full factory guarantee on reconditioned components (not repair)	•	
Full range of Liebherr components	•	
Component exchange within 24 hours with proactive ordering (plus time for transportation)	•	
Fixed buyback price for unrepaired component – “core credit”	•	
Reduced inventory costs through on-demand component exchange	•	

Investing in machine maintenance helps minimise total cost of ownership, regardless if it is for an earth moving, material handling or mining machine, or a mobile or maritime crane. Liebherr remanufactured components ensure a cost effective solution at an attractive price.

High profitability

Reman components from Liebherr guarantee machine productivity and availability at a more favourable price than new components. In this way, Liebherr machines remain assets throughout their entire economic life. With Exchange Components, General Overhaul, and Repair Components, the Liebherr Reman Program offers cost effective solutions for every customer requirement.

Low operating costs

High quality remanufactured components can significantly reduce machine maintenance costs. Especially in comparison with third-party repair workshops, Liebherr Reman components offer superior customer value (see table).

Proactive cost management

For Exchange Components and General Overhaul, prices and guarantee conditions are clearly defined from the start. In this way, customers can better forecast and proactively manage machine life cycle costs. In addition to this, downtimes are reduced due to fast delivery and quick installation, thereby increasing machine availability and productivity.

Cost comparison by reman service level*

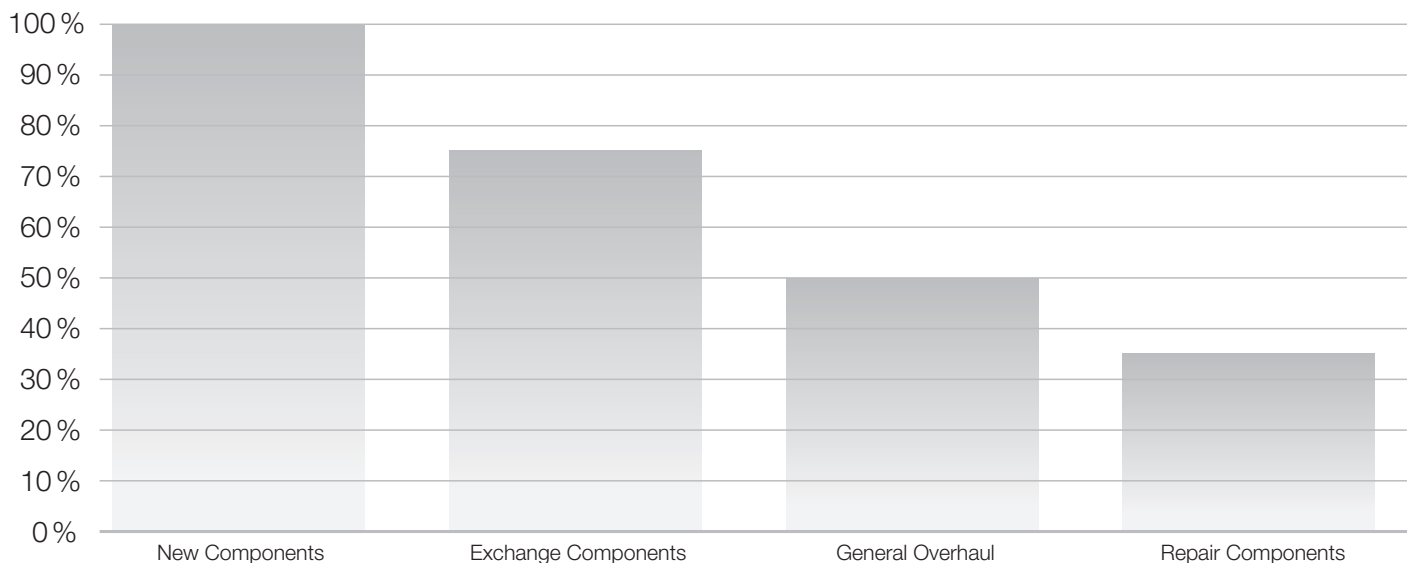

* Applies to single order

Quality and availability

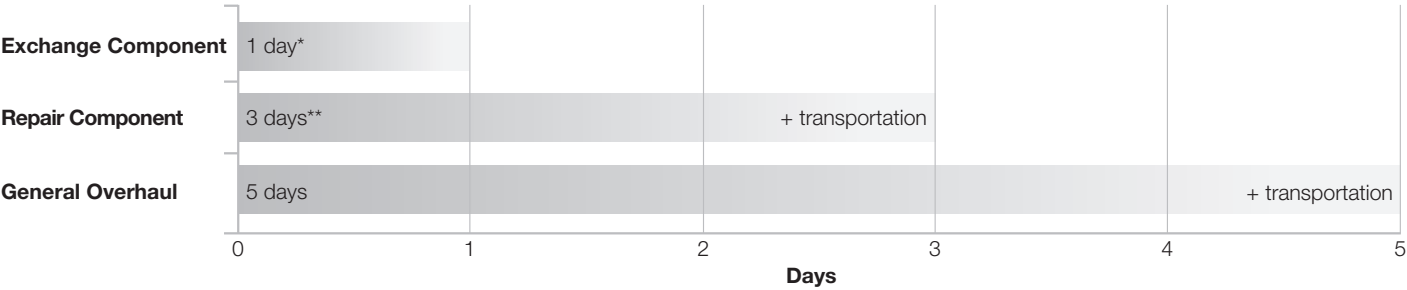

* with proactive ordering

** after placing of order

OEM know-how with original parts for demanding customer requirements

Liebherr uses only original parts in the remanufacturing process, which together with OEM know-how returns components to their original as-new condition. Only Liebherr has the in-depth product knowledge to deliver this level of quality.

Quality guaranteed

With Liebherr, customers can trust in the latest product and process expertise. For example, Liebherr designs and manufactures almost all drivetrain components in-house. This know-how ensures the highest remanufacturing quality for both components and individual parts. For this reason, the same guarantee and test standards that apply to new components also apply to Exchange Components and to General Overhaul.

Minimize downtime with optimal logistics

Machine downtimes can incur high costs, for example in the mining industry. With Exchange Components, Liebherr can provide remanufactured components for same day removal and installation, when ordered in advance. This increases the availability and productivity of the machine.

Original parts service: Fast and reliable delivery

Every hour counts when minimizing the total cost of owning and operating a Liebherr machine. For this reason, the original parts service from Liebherr is available 24/7. Liebherr's original parts supply is supported by a powerful IT system and utilizes sophisticated logistics concepts. Liebherr-P@rts24, the electronic original parts catalogue, enables fast and reliable selection of the correct parts as well as immediate online ordering*. The standardised daily overnight distribution service ensures fast, nationwide delivery of components*.

* Depends on country and product



The European Reman Competence Centre in Ettlingen



Liebherr has numerous component remanufacturing and repair facilities around the world that cater specifically to the local market requirements. At Liebherr-Ettlingen GmbH, Germany, components such as diesel engines, slewing drives, travel drives and swivelling drives, splitter boxes and hydraulic pumps and motors, hydraulic cylinders, axles and particulate filters are reconditioned centrally for earth moving, material handling and mining machines as well as mobile and maritime cranes. Economic reconditioning of components takes place at an industrial level for all three component remanufacturing and repair services: Repair Components, General Overhaul, and Exchange Components. As such, Liebherr-Ettlingen GmbH can provide technical and process expertise to all Liebherr component remanufacturing and repair facilities around the world.

According to the Reman Centre in Ettlingen Liebherr has established three further Reman sites on three continents:

- Nizhny Novgorod/Russia: Diesel engines and gearboxes
- Burlington/Canada: Diesel engines
- Guaratingueta/Brazil: Diesel engines, hydraulic components and gearboxes

The Reman process

The used component returned by the customer is completely disassembled. Wear parts are disposed of and potentially reusable parts are stripped of paint, cleaned and appraised according to strict guidelines: With the aid of automated tolerance measurements and inspections for cracks, the suitability for reconditioning of every part is determined. Industrial machining processes then restore the parts to as-new quality before being inspected and reused. Finally, the entire remanufactured component is tested based on the same criteria and inspection report as the respective new component.

Highest quality standards

Experienced, qualified specialists incorporate up-to-date product and process expertise from the original manufacturer into remanufacturing and repairing components and individual parts. To ensure consistently high quality all components are tested using the inspection report from the new component. As an example, the following test benches have been setup for testing engines and hydraulic pumps and motors:

- Engine test bench for diesel and gas engines with an output of up to 800 kW
- Hydraulics test bench for hydraulic pumps and motors with pressures of up to 450 bar and speeds of up to 4,000 rpm

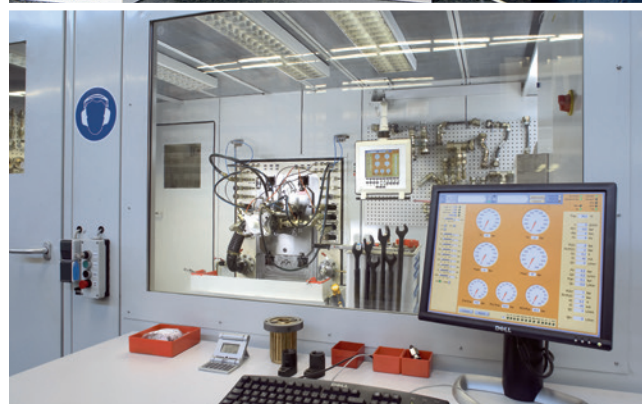
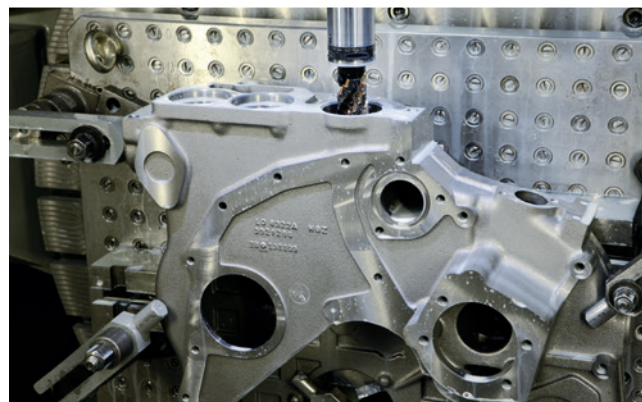

The Reman Program for Liebherr machines



At Liebherr, customer service is of highest priority. For this reason, comprehensive aftersales services are available that are tailored to the individual customer requirements for each machine. As a cost-effective alternative to the new parts, Liebherr offers three component remanufacturing and repair services: Exchange Components, General Overhaul, and Repair Components.

Earth moving and material handling machines

The requirements for earth moving and material handling machines are as diverse as the range of equipment. For this reason, customers of mobile and crawler excavators, crawler tractors and crawler loaders, wheel loaders, articulated trucks and material handling equipment can choose a solution from the Reman Program that is tailored to their individual requirements.

Mobile and crawler cranes

There are more than 28,500 cranes in operation around the world and quick delivery and availability of replacement parts is of significant importance. The Liebherr Reman Program offers a fast and ideal solution for every requirement.

Mining equipment

Mining hydraulic excavators and mining dump trucks are operated on a continual basis. Therefore, fast parts availability and reliability have the highest priority. Exchange components satisfy this requirement exceptionally well as they are ready for immediate installation when the customer orders in advance.

Maritime cranes and port equipment

Included in the broad product range of maritime cranes and port equipment are, for example, mobile harbour cranes, ship and offshore cranes as well as reachstackers. Also for these machines, a variety of components are available from the Liebherr Reman Program.



Overview of the Reman Program

	Axles ¹⁾	Diesel engines ²⁾	Travel drives	Hydraulic pumps and motors
Earth moving and material handling machines				
Wheeled excavators	•	•		•
Crawler excavators		•	•	•
Wheel loaders	•	•		•
Crawler tractors	•	•	•	•
Crawler loaders		•	•	•
Dumpers		•		•
Duty-cycle crawler cranes		•	•	•
Telescopic handlers	•	◦		•
Mining equipment				
Mining trucks		•		•
Mining excavators		◦	•	•
Mobile and crawler cranes				
Telescopic mobile cranes	•	•	•	•
Telescopic crawler cranes		•	•	•
Telescopic compact cranes	•	•	•	•
Lattice / boom cranes	•	•	•	•
Crawler cranes		•	•	•
Maritime cranes and port equipment				
Reachstacker	◦	•	•	•
Ship cranes			◦	•
Offshore cranes		•		•
Mobile harbour cranes	◦	•	•	•
Deep foundation machines				
Piling- and drilling rigs		•	•	•

◦ Availability depends on machine type

• Available

¹⁾ Axle inserts (differential), axle differential

²⁾ Starter, injection pump, alternator, turbocharger, cylinder head, water pump, lube oil pump

³⁾ Shock absorber, steering cylinder

Hydraulic cylinders³⁾

Pump regulator valves

Splitter boxes

Swivelling drives

Rope winches

Hydraulic cylinders ³⁾	Pump regulator valves	Splitter boxes	Swivelling drives	Rope winches
○	○	•	•	
○	○	•	•	
	○	•		
	○	•		
	○	•		
	○	•	•	○
•		•		
•	•			
•	•	•	•	
•	•	•	•	•
•	•	•	•	•
•	•	•	•	•
•	•	•	•	•
•	•	•	•	•
•	•	•	•	•
•	•	•	•	•
	○	•	•	○

The Liebherr Group of Companies



Wide Product Range

The Liebherr Group is one of the largest construction equipment manufacturers in the world. Liebherr's high-value products and services enjoy a high reputation in many other fields. The wide range includes domestic appliances, aerospace and transportation systems, machine tools and maritime cranes.

Exceptional Customer Benefit

Every product line provides a complete range of models in many different versions. With both their technical excellence and acknowledged quality, Liebherr products offer a maximum of customer benefits in practical application.

State-of-the-art Technology

To provide consistent, top quality products, Liebherr attaches great importance to each product area, its components and core technologies. Important modules and components are developed and manufactured in-house, for instance the entire drive and control technology for construction equipment.

Worldwide and Independent

Hans Liebherr founded the Liebherr family company in 1949. Since that time, the enterprise has steadily grown to a group of more than 130 companies with over 41,000 employees located on all continents. The corporate headquarters of the Group is Liebherr-International AG in Bulle, Switzerland. The Liebherr family is the sole owner of the company.

www.liebherr.com

Liebherr-Ettlingen GmbH

Hertzstraße 9-15, D-76275 Ettlingen

+49 7243 708-0, Fax +49 7243 708-685

E-Mail: info.let@liebherr.com

www.reman.liebherr.com