

LCM 1.0

Horizontal concrete batching plant



LIEBHERR

LCM 1.0

Horizontal concrete batching plant



Economic batching plant with unique advantages

The LCM 1.0 concrete batching plant combines solid construction, cost-effective transport and assembly with an attractive price/performance ratio. A wide variety of concrete recipes are produced reliably and in high quality. The plant is equipped with a powerful ring-pan mixer and produces up to 69 m³ of fresh concrete per hour. The entire concept is designed for high efficiency and a long service life. Modern technology at an affordable price.



Various mixer options for customer-specific requirements

- Liebherr ring-pan mixer for standard to high-performance concrete types
- Optionally with agitator system for maximum efficiency

Efficient aggregate storage in an in-line silo

- Standard in-line silo with 4 x 10 m³ filling volume
- Optionally, the transport optimised in-line silo with 4 x 25 m³ filling volume is also possible

Modern control system

- Easy and intuitive control system via laptop
- Clear display of the essential operations
- Constant monitoring of the mixing process through fixed scale displays

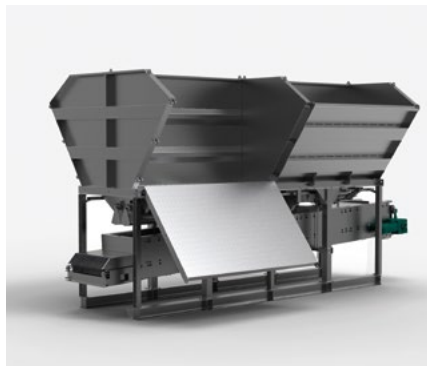

LCM 1.0

Economic transport and assembly



Cost-effective transport and mobile plant concept

The LCM 1.0 concrete batching plant, designed for economical concrete production, enables a simple, fast as well as cost-effective transport in 2 x 40ft. HC containers. Thus, the concrete batching plant ensures a high degree of mobility and offers the possibility of an uncomplicated and rapid relocation of the plant.

Cost-efficient transport

in 2 x 40ft. HC containers thanks to the well planned and space-saving concept of the concrete batching plant

Time-saving assembly

Plant can be lifted in a single operation with the aid of a crane

Mobile concept

In order to be able to realise the quickest and simplest possible assembly, foldable components and pre-mounted steel foundations are used

Quick and easy assembly

leads to minimal foundation work

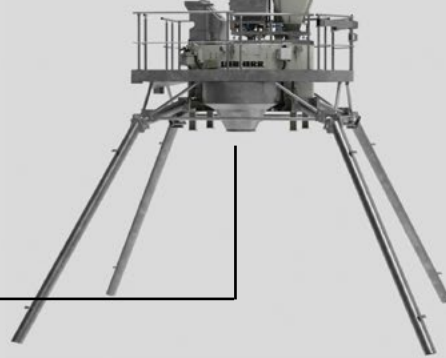

QR code
to the video



LCM 1.0

Litronic-BCS 3 control system



Modern Control system

The Litronic-BCS 3 is a fully automatic, real-time capable control system with extensive features. All standard tasks as well as data management can be carried out conveniently. The simple operation of the control system via two monitors allows the operator parallel master data management and visualisation of the process flow. The visualisation components can be freely adapted. In addition, the system has automatic safety monitoring. Manual intervention during the automatic runtime is possible at any time.

The right mixer for every task



Competence in mixing technology

Liebherr has been developing and producing its own mixer systems for over 60 years. In the company's own mixing technology laboratory, the mixer systems are constantly being further developed and optimised during tests with a wide range of materials. The main focus of development is the realisation of a long mixer service life, a high output rate with consistently high quality as well as a maintenance-friendly arrangement of all service elements.

The LCM 1.0 is equipped with an efficient Liebherr ring-pan mixer. In addition, if required, even demanding mixing tasks can be solved fast and easily by using an agitator system.

Ring-pan mixer type R 1.0

- Designed for all standard recipes
- The arrangement of the mixing tools is optimised to mix the raw materials quickly and efficiently to obtain the desired mixing result

Ring-pan mixer with agitator system type RIM-M 1.0

- The agitator system ensure intensive mixing performance and also master demanding recipes
- The agitator breaks up the cement faster and homogenises the mixture in a shorter time

From standard to high-tech, always the right product

- Thanks to the adaptation options, the ring-pan mixer are ideal for any mixing task, from standard to high performance concrete
- The optimum solution for every mixing task

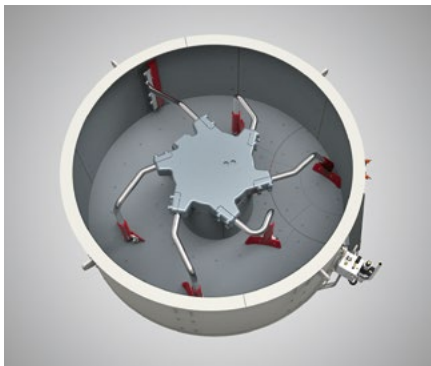

LCM 1.0

Technical data

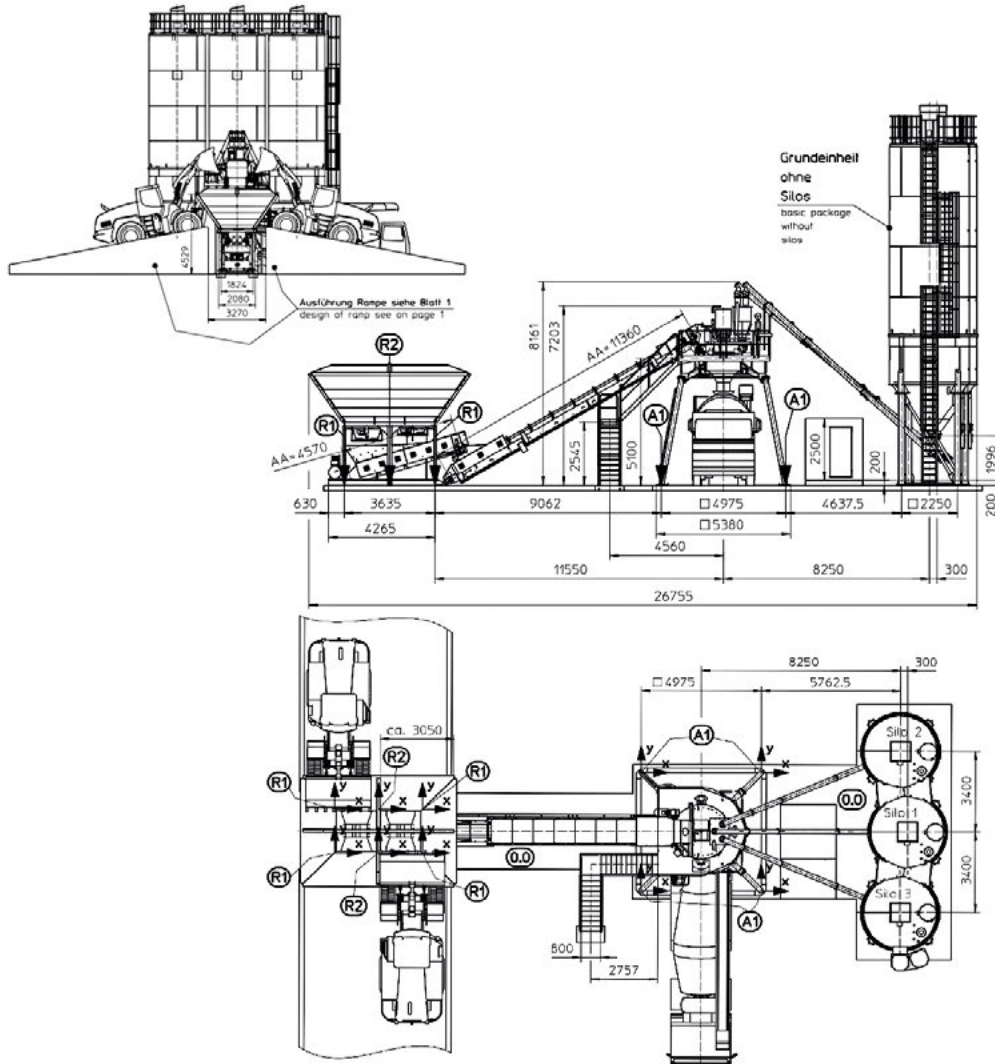

Technical data	LCM 1.0
Theoretical discharge output in compacted mixed concrete*	69 m³/h
Theoretical discharge output in compacted mixed concrete**	58 m³/h
Mixer type	Ring-pan mixer R 1.0/RIM-M 1.0
Max. number of aggregate chambers in-line silo	4
Max. aggregate storage capacity in-line silo	100 m³
Max. aggregate storage capacity in-line silo per chamber	25 m³
Max. number of aggregate chambers pocket silo	4
Max. aggregate storage capacity pocket silo	40 m³
Max. number of cement types	3
Feeding	Belt
Max. filling amount of each cement silo	100 t

* by 20 sec. mixing time

** by 30 sec. mixing time

Liebherr-Mischtechnik GmbH

Postbox 145, 88423 Bad Schussenried / Germany

Tel: +49 7583 949-0, Fax: +49 7583 949-396

www.liebherr.com, E-Mail: info.lmt@liebherr.com

www.facebook.com/LiebherrConstruction