

Litronic-FMS

# Reliable Moisture Measuring System



# LIEBHERR

# Hightech Sensors "Made in Germany"



Since 1985 Liebherr develops, produces and distributes efficient moisture measurement systems for the industrial automation around the world. At the Liebherr factory in Bad Schussenried the sensors are produced and calibrated in an ESD-protected production line. Each sensor will be tested separately in a several hour process across the entire working temperature range before leaving the factory.

## Development

Sensor development at Liebherr includes the total R&D value chain from the physical idea to the final solution, from the first concept to the finished product.

The competent electronic development and the experience from the field of construction machines under extreme conditions guarantee a very high reliability and a long life time of the sensors.

During the development phase FEM-simulations allow accurate statements about the future characteristics of the sensors ►

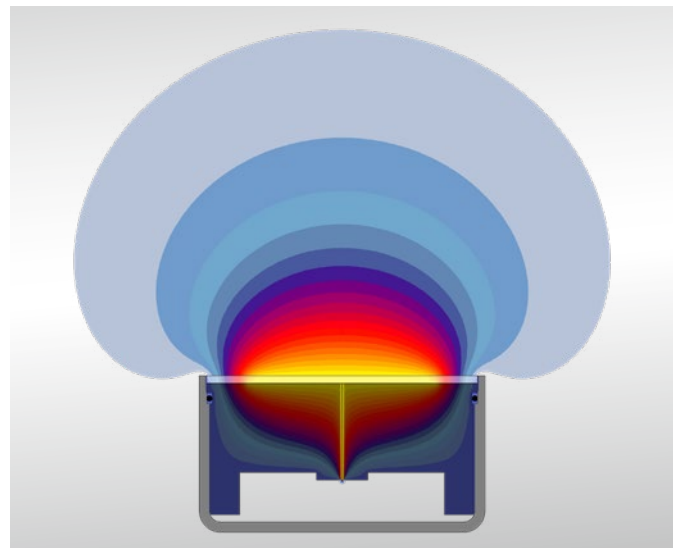

# Technical Data

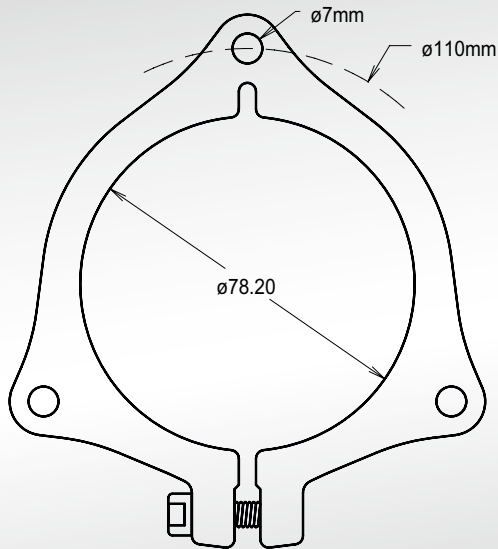

Sensor P78 with clamping flange

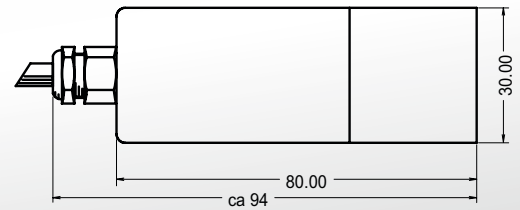
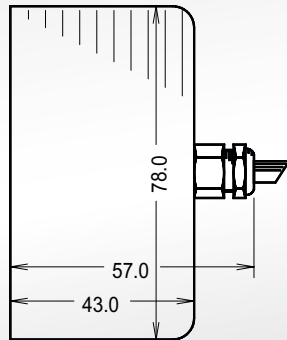

Sensor P30

## Sensor/Electronic module

Measuring range	0–100 % moisture content
Physical principle	Capacity determination with high-frequency leakage field
Field Frequency	20 MHz
Capacity resolution	$1 \cdot 10^{-15}$ F
Cycle of up-date	32.64 ms
Sampling rate	$16 \times 10^6 - 25 \times 10^6$
Measuring precision max.	$\pm 0.05$ % moisture content <sup>1.)</sup>
Measured value transmission	digital EIA485, RS485
Max. number of sensors at bus	16
Max. bus cable length	1.2 km
Ambient temperature sensor	-20–80 °C (100 °C optional)
Working temperature electronic	-20–80 °C
Protection class	IP68
Wearing protection	ZrO <sub>2</sub> Al <sub>2</sub> O <sub>3</sub> / PEEK
Material shell / flange	V4A (1.4404)
Temperature measurement	NTC 10k plus/minus 1 %, R/T 8016 <sup>2.)</sup>

1.) Depending on ideal material, flowability and calibration according to the rules.

2.) Mixing temperature - medium, work environment

# System Overview

An autonomous stand-alone-system with almost unlimited possibilities. Highest quality and best results during process are guaranteed by the exact material moisture measurement.

The Litronic-FMS will meet your requirements in any case. An easy-to-use PC software enables a fast and exact calibration.

## Features

- Modular expandable construction
- Fully reproducible sensors
- Adjustable measuring range
- Material curves change over
- Material temperature compensation
- Suitable for high material flow
- Interference-free digital signal transmission
- Installation of electronic components on DIN mounting rail (TS-35)
- Suitable for batch and continuous processes
- High connectivity
- Optional:
  - Process display
  - Temperature measurement <sup>2.)</sup> (sensor P78 only)
  - Sensor with ATEX explosion protection category 3D



**Litronic-FMS planar sensor P78 <sup>2.)</sup> with temperature measurement and clamping flange**

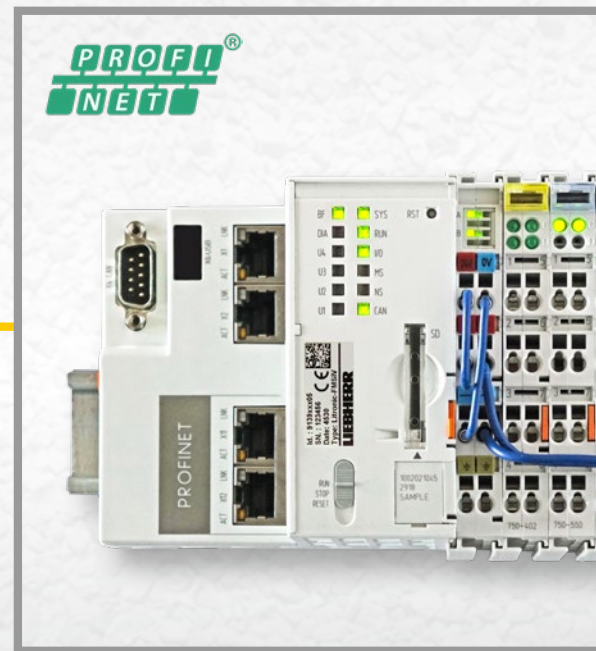
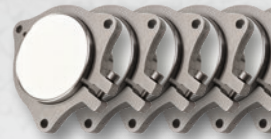

**Parameterisation and visualisation by Litronic-FMS PC-software**



Measurement value transfer moisture/temperature





Up to 16 sensors



Sensor P30

Evaluation via Profinet or Profibus DP possible

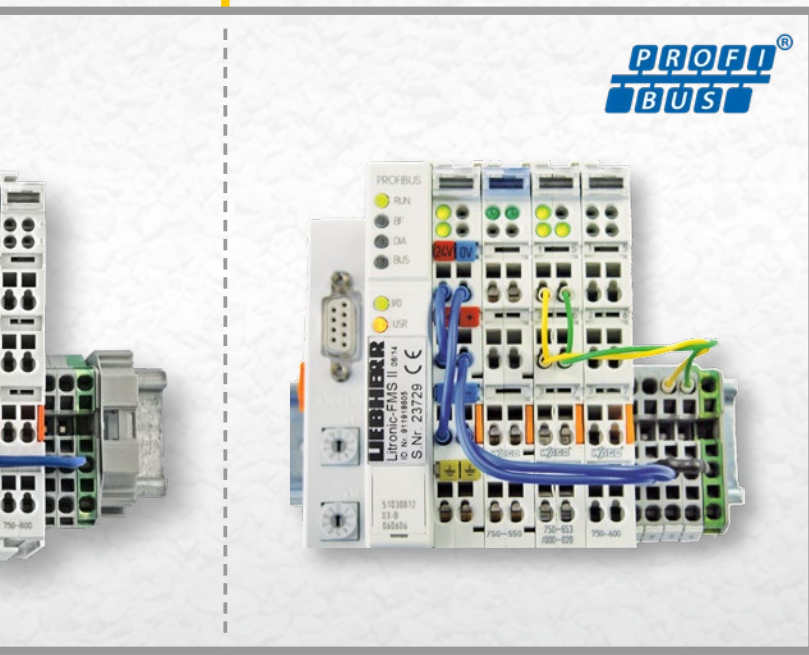

Profinet or Profibus DP

Analogue output  
0-10V 12 bit  
or 0/4-20 mA 12 bit

Digital outputs  
for limit signal

Digital inputs for start/stop  
control and material curves  
change over

modularly  
expandable →

Ethernet



— = Standard

— = Option

# Application Examples



Sensor installed in material chute under silo outlet

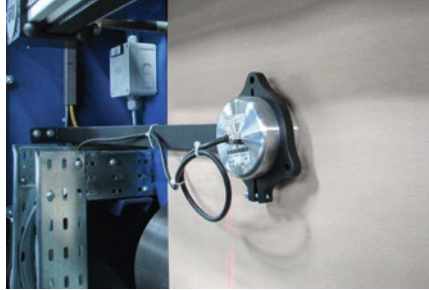

In the paper and cardboard industry



For sand and other aggregates

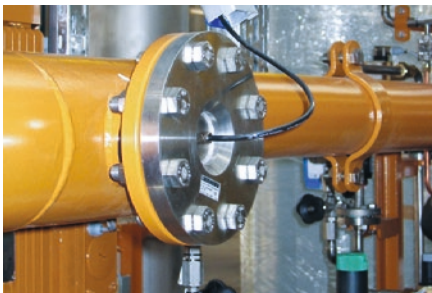

With DN 80 flange for diesel, oil and other emulsions



In sliding shoe for cullet (recycling glass)

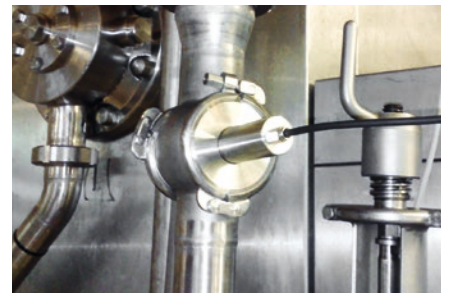

Food compliant execution e.g. for margarine

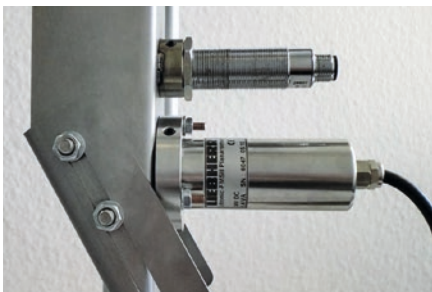

Sensor P30 for small and space limited plants, e.g. for powder and fine aggregates

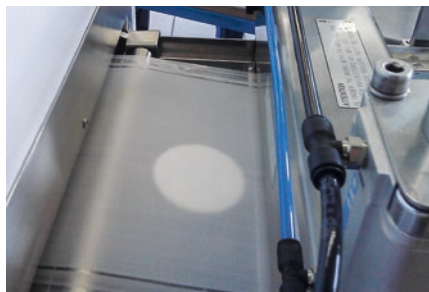

Fleece-, film- and felt webs



For wooden chips, sawdust, etc.

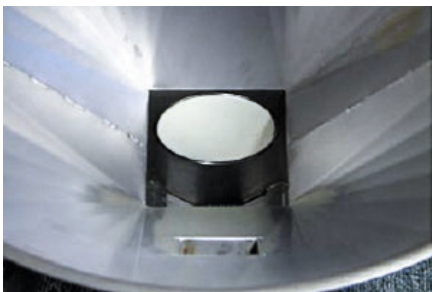

View in a bulk funnel with installed sensor

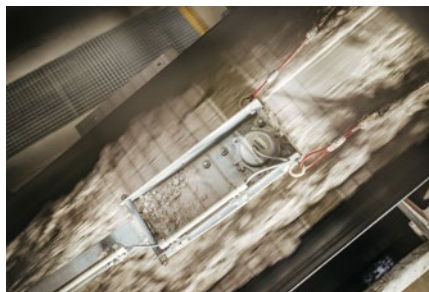

In sliding shoe for quartz sand (glass, building material and ceramic industry)



Use in the fluidised bed dryer in seed production

### Bulk materials

- Sand, quartz sand
- Shattered glass, soda
- Incineration and flue ash
- Ore, minerals, sinter
- Dust, slag
- Aggregates
- Faundry sand
- Raw materials, filter cake
- Ceramic powder
- Coal, coke, charcoal
- Gypsum, talc
- Lime, loam, clay
- Granulates
- Fertilizer
- Earth, Soils
- Recycled materials
- Carton and paper webs
- Fleece, plastic film, felt webs
- Plastic granules
- Shredded plastic
- Different pellets
- Colour pigments
- Washing powder, detergent
- Cork
- Wood fibre, -slab, -chips
- Sawdust
- Cat litter
- Pet litter
- Silage, forage
- Biomass, digestates, straw
- Silica
- Pet food (dry + liquid)
- Coarse grain, cereals, mash
- Food and luxury food
- Fruit shavings, marc
- Seed, sugar beet pulp
- Sprouts
- Corn, maize, malt
- Rice
- Sugar, salt
- Flour
- Marzipan
- Coffee, cocoa
- Tea
- Gelatine, -capsules
- Tobacco
- Lactose, cellulose
- ...

### Emulsions

- Diesel, biodiesel
- Oil, crude oil, hardening oil
- Wax, resin
- Margarine
- Coolants and lubricants
- Sludge
- Methyl, ethanol, acetone
- Grease
- Glue
- Paint and colour
- Solvents
- Ceramic slurry
- ...

### Installation places

- Silo outlets
- Material chutes
- Buffle plates
- Conveyor belts
- Transfer points
- Dryers
- Screw conveyor
- Pipes
- Tanks

### Options and accessories



Sliding shoe



Sensor with ATEX explosion protection category 3D



Weld-on fitting for P30

# High-tech from Bad Schussenried



## Experience worldwide.

Liebherr-Mischtechnik GmbH is one of over 130 companies in the Liebherr Group. The experience gained in the development and manufacture of concrete mixing plants led to the development of the measuring systems division. For the sand moisture measurement in these plants alone, thousands of moisture sensors are successfully in use worldwide.

## Further measurement technology products:

For use in explosive atmospheres Liebherr offers a moisture sensor for bulk materials with ATEX explosion protection of the equipment category 3D. For liquids and dusts of categories 1G and 1D the water content sensor type Litronic-WMS. Further measurement technology products, such as coating thickness measurement and weight per unit area determination, can be found on our homepage at [www.liebherr.com](http://www.liebherr.com) in the Components/Measurement Technology section.

