

EN

LR 1100.1

LR 8503.02.03
www.liebherr.com

LIEBHERR

Crawler cranes



Concept and characteristics	3
Technical description	6
Dimensions	8
Transport dimensions and weights	9
Self-assembly system	12
Boom combinations	13
Main boom 1512.21	14
Fixed jib 0806.21	16

Remarks

- The load capacities stated are valid for lifting operation only (corresponding with crane classification according to ISO 4301-1, crane group A1).
- Machine is standing on firm, horizontal ground.
- The weight of the lifting device (pulley block, hoist ropes, shackles, etc.) must be deducted from the load capacity.
- Additional equipment on boom (e.g. walkways) must be deducted from the load capacity.
- The max. admissible wind speed can be preselected in the LML software and referred to in the load chart.
- Working radii are measured from centre of swing and under load.
- The lifting capacities are valid for 360 degrees of swing.
- Calculation of stability under load was carried out according to ISO 4305 Table 1 + 2 + 3, tipping angle 4°, as well as ANSI/ASME B 30.5 and was tested according to SAE J765 and SAE J987.
- The steel structures are calculated according to EN 13001-1; EN 13001-2.
- The last digits of the given dimensions are rounded to 0 and 5 and may differ from the actual dimensions.
- Weights may vary depending on the delivered configuration of the machine, filling level of the tanks, as well as generally valid tolerances.
- The figures in this brochure may include options which are not within the standard scope of supply of the machine.
- Subject to technical change without notice.

Concept and characteristics

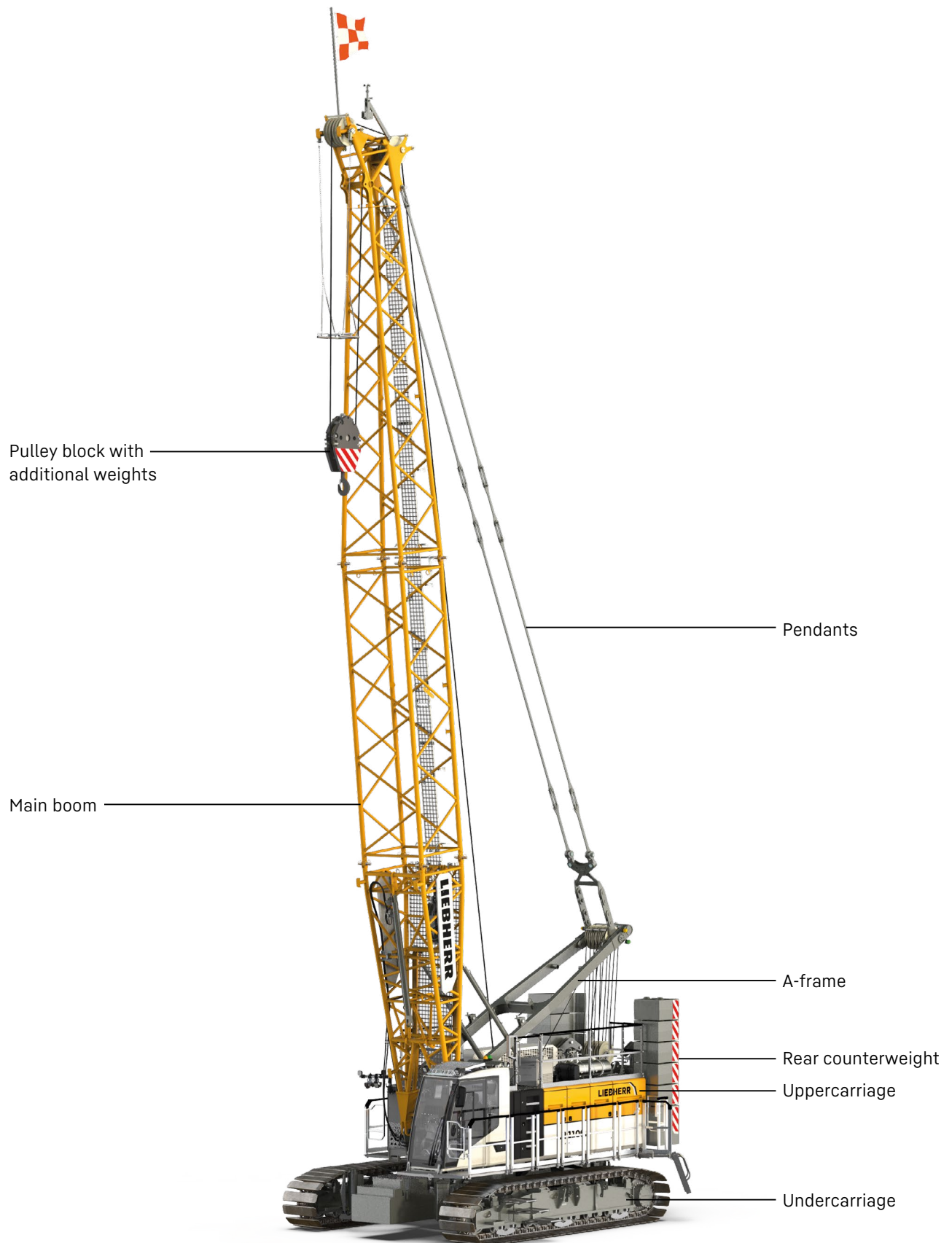

Cabin with high comfort
- optimized view
- noise-reducing design
- orthopaedic seat

Crawler side frames with
900 mm flat track pads

Carbody counterweight

Platforms



High performance

A strong, efficient and reliable diesel engine of the newest generation provides high performance and enables several movements to be carried out simultaneously.

Ground pressure

The actual ground pressure is calculated according to the configuration and position of the machine and displayed in the operator's cabin. Using the optional Liebherr Crane-Planner the actual ground pressure can already be calculated and displayed in the planning stage.

Travelling with load

By preselecting one of the three travel speeds, the control automatically applies the permitted load curve.

Stage 1: up to 0.1 m/s

Stage 2: up to 0.4 m/s

Stage 3: more than 0.4 m/s

Cabin with high comfort

Optimised field of vision combined with enhanced comfort: an orthopaedic operator's seat with heating and cooling functions, as well as precise and ergonomic controls are included.

Control

Easy and intuitive handling of control, service and machine functions through a large, clear colour monitor. Built for extreme environmental conditions.

Barge operation

By preselecting the barge inclination the control automatically applies the permitted load curve.

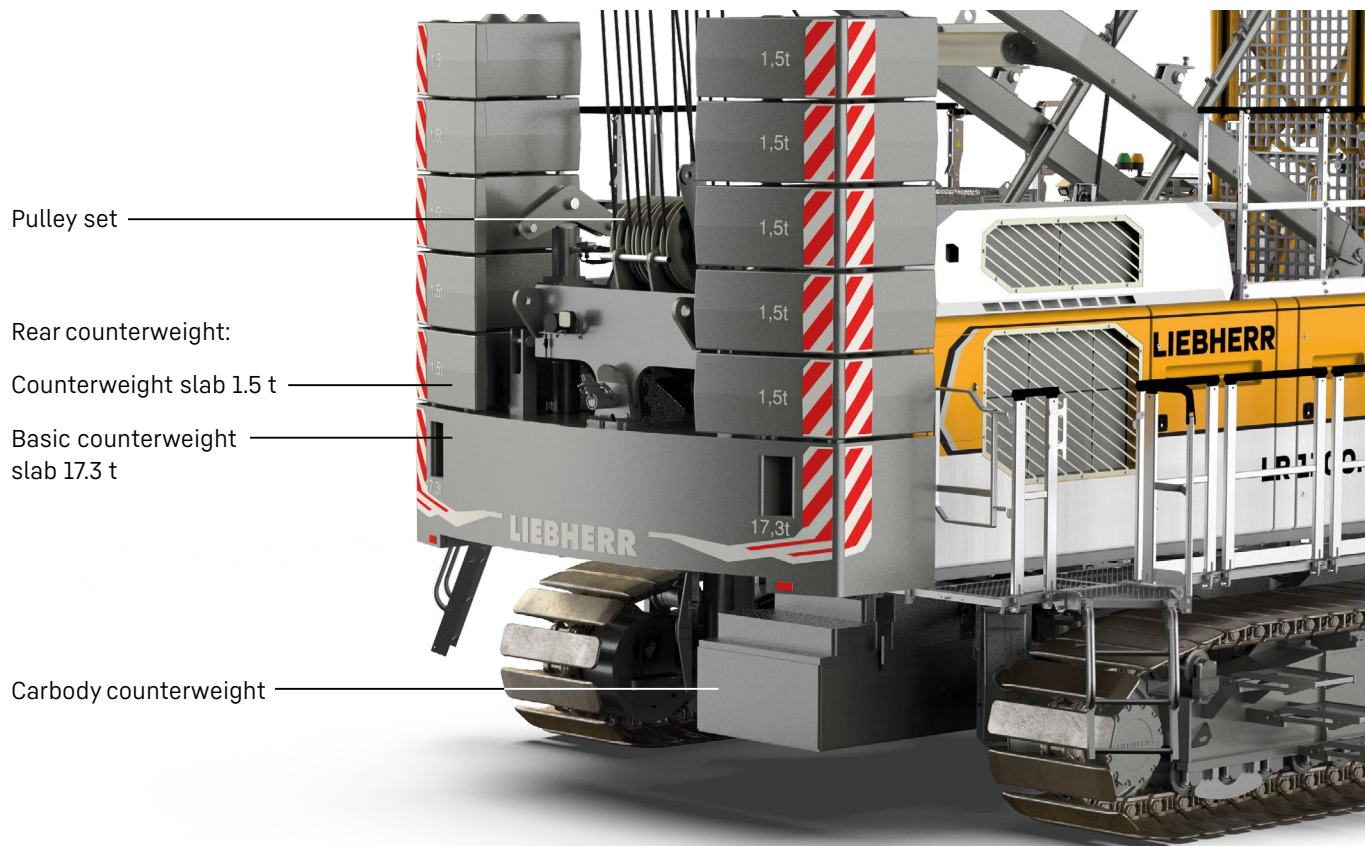

Pulley set

Rear counterweight:

Counterweight slab 1.5 t

Basic counterweight slab 17.3 t

Carbody counterweight

Efficient self-assembly system and short assembly times

The self-assembly system enables safe, independent and quick assembly/disassembly of the crawler side frames, the carbody and rear counterweights, as well as boom elements.

Easy service

The design ensures easy maintenance and service as well as safe access to the components.

Mobility

Crane parts are optimized for transportation. The maximum transport width is 2.98 m.

Boom

The boom systems and configurations allow for optimum operation on the most diverse jobsites.

Preselection of customised load curves

Different wind speeds. The driver can preselect appropriate and permitted load curves for different wind speeds by pressing a button directly on the monitor.

Technical description



Diesel engine

Power rating according to ISO 9249	230 kW (308 hp) at 1700 rpm
Engine type	Liebherr D 944 A7-05
Fuel tank capacity	400 l with continuous level indicator and reserve warning
Exhaust certification	Version 1: 97/68 EC Stage IV and EPA/CARB Tier 4f Version 2: 97/68 EC Stage V and EPA/CARB Tier 4f Version 3: ECE-R.96 Power Band H Version 4: without certified emission standard



Noise measurement data and vibration

Noise emission	according to 2000/14/EC directive
Emission sound pressure level L_{PA}	72 dB(A) (in the cabin)
Guaranteed sound power level L_{WA}	108 dB(A) (of the machine)
Vibration transmitted to the machine operator	< 2.5 m/s ² (to the hand-arm system) < 0.5 m/s ² (to the whole body)



Hydraulic system

Hydraulic pumps	double axial displacement pump in open loop hydraulic system allows all functions to be operated simultaneously automatic working pressure cut-off to minimize peak pressure
Hydraulic oil tank capacity	820 l
Max. working pressure	350 bar
Hydraulic oil	electronic monitoring of all filters use of synthetic environmentally friendly oil



Control

Control system	includes all control and monitoring functions, designed to withstand extreme environmental conditions and heavy construction tasks
Display	colour touchscreen in the operator's cabin, clear display of complete machine operating data, warnings and failure indications in the required language
Operation	several movements can be performed simultaneously thanks to electro-hydraulic proportional control, all categories of loads can be positioned with utmost precision



Crawlers

Drive system	with fixed axial piston hydraulic motors
Crawler side frames	maintenance-free, with hydraulic chain tensioning device
Brake	hydraulically released, spring-loaded multi-disc holding brake
Drive speed	0-1.5 km/h
Flat track pads	width 900 mm



Swing gear

Drive system	with fixed axial piston hydraulic motors, planetary gearbox, pinion
Swing ring	roller bearing with external teeth
Brake	hydraulically released, spring-loaded multi-disc holding brake
Swing speed	0-2.7 rpm continuously variable
Speed control	both swing modes are possible - speed control or free swing for speed control: a multi-disc holding brake locks automatically at zero swing motion.



Hoisting gear

Standard crane winches 1 + 2	internal low-maintenance planetary gearbox in oil bath, load support by the hydraulic system, spring-loaded, multi-disc holding brake, pressure controlled, variable flow hydraulic motors for the main winches, full utilisation of engine power as the winch speed is automatically adjusted to suit the respective line pull
Line pull in the 7th layer	120 kN
Rope diameter	26 mm
Drum diameter	580 mm
Rope speed	0-136 m/min
Rope capacity in 4 layers	256 m
Option - winches 1/2 as free-fall winches	free fall: clutch and braking functions are provided by the service brake (low wear and maintenance-free multi-disc brake in compact design)







Boom/jib luffing winches

Main boom	
Line pull	max. 86 kN
Rope diameter	20 mm
Boom luffing	15-84° in 58 s

Operating weight

Composition of operating weight	basic machine with crawler side frames (with 900 mm flat track pads), winches 1 + 2, A-frame, 1 rope 220 m, 14 m main boom, consisting of boom foot (5.5 m) and boom head (8.5 m) 29.3 t rear counterweight (8 × 1.5 t + 1 × 17.3 t) 15.3 t carbody counterweight (2 × 7.65 t) 40 t pulley block
Total weight	approx. 94.4 t

Operation modes

	 Lifting mode	 Grab mode	 Foundation work
 Land	✓	✓	✓
 Floating structure (barge operation)	✓	✓	✓

Optional equipment

Basic machine

Carbody counterweight remains on undercarriage (transport)
 Crawler side frame detachable, 3-web, 900 mm
 Crawler side frame detachable, flat, 900 mm
 Crawler side frame non-detachable, 3-web, 900 mm
 Load hook 12.5 t
 Rotation-free hoist rope, 26 mm, 1960 N/mm², 180 m
 Rotation-free hoist rope, 26 mm, 1960 N/mm², 220 m
 Painting in customer design
 Pulley block 40 / 80 / 100 t
 Winches 1/2 as free-fall winches (12 t)

Economy and ecology

Aux. power unit (APU, 2.8 kW)
 Eco-Silent Package

Boom/jib

Auxiliary jib 24 t for main boom
 Fixed jib 15° (11 m or 20 m)

Boom/jib other

Walkways for main boom sections 6 / 12 m
 Rope guide (over 50 m)

Application packages

Cabin elevator 2.8 m hydraulic
 External supply incl. battery charger (100-240 VAC / 750 W)
 Main winch constant tension for one winch
 Radio remote control
 Radio remote control (preparation)
 Rope reeving function via radio remote control
 Tagline winch 2 t free fall
 Third winch 7 t (auxiliary winch)
 Third winch 7 t (auxiliary winch): preparation
 Two hook operation
 Winch synchronization

Special features

Crane Planner 2.0
 LiDAT
 Self-assembly system
 Jack-up system telescopic
 Reeving winch
 Self-assembly cylinder on boom foot
 Self-assembly system rear counterweight

Service package

Electric central lubrication swing ring bearings
 Electric central lubrication swing ring bearings / outside
 Cold package -25 °C
 Cold package -40 °C
 Gear oil level warning (hoist winches, swing gear, boom luffing winch)
 Hydraulic oil bypass filter
 Liebherr hydraulic oil plus arctic (longlife & bio)
 Liebherr hydraulic oil plus arctic (longlife)
 Liebherr hydraulic oil plus-37 (longlife & bio)

Safety features

Access control
 Aircraft warning light
 Assistance system: Gradient Travel Aid
 Assistance system: Ground Pressure Indication and Visualization
 Cabin protection roof, FOPS2, foldable
 Earth spike
 Lifting height indication for both hoist winches
 Lightning rod
 Lightning rod with airport flag holder
 Optical angle display
 Platforms and handrails on uppercarriage (left/right) incl. access ladder
 Platforms on uppercarriage (left/right)
 Plug&Play back-up unit, 18.4 kW
 Plug&Play back-up unit, 18.4 kW: preparation
 Safety upgrade APAVE
 Swing warning light
 Vandalism cabin protection
 Winch camera
 Anemometer
 Swing and boom radius limit device
 Zoom camera at boom head

Operator's comfort

Additional ignition key
 Additional LED floodlights on boom foot, manually adjustable
 Cabin air conditioner
 Cabin tilting device hydraulic
 Uppercarriage inclination indicator on cabin monitor

Dimensions

Basic machine with undercarriage

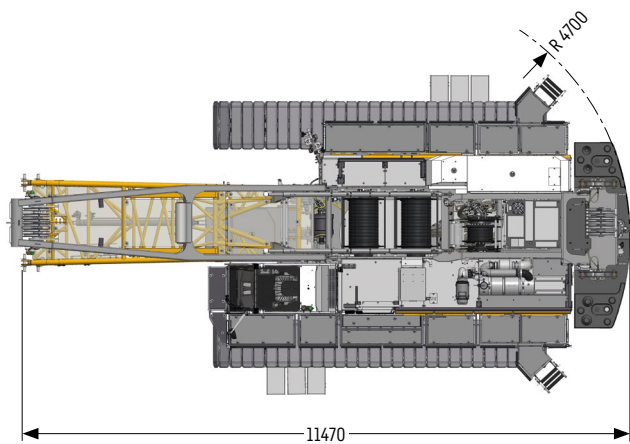
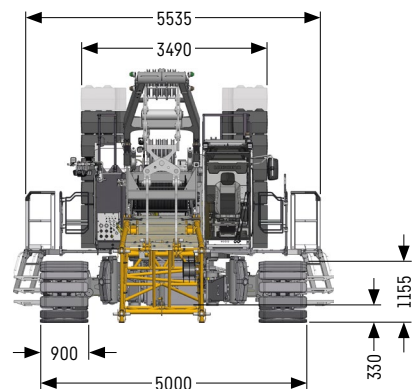
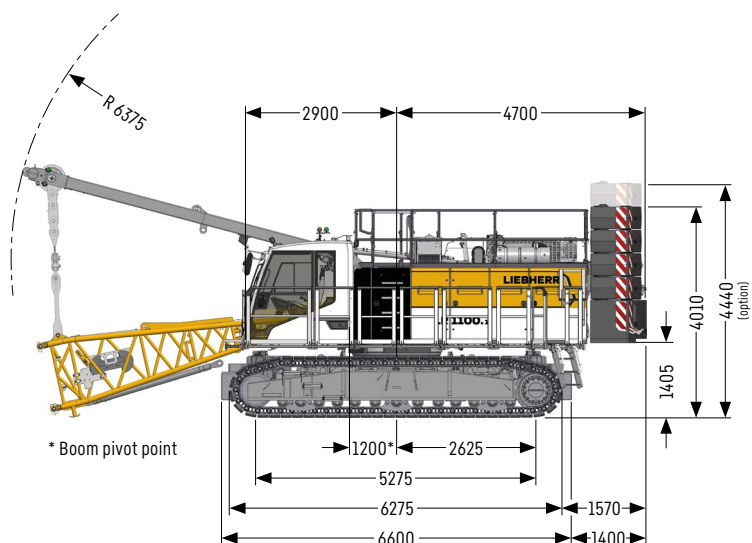

Transport dimensions and weights

Basic machine and main boom 1512.21

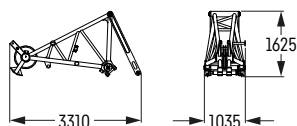
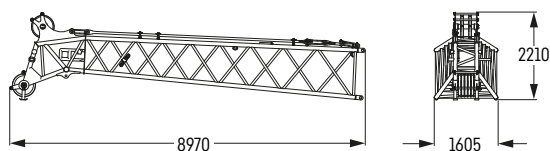
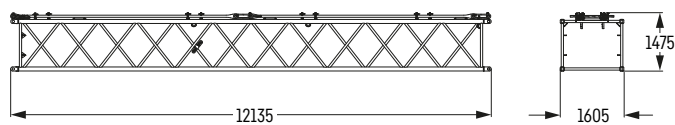
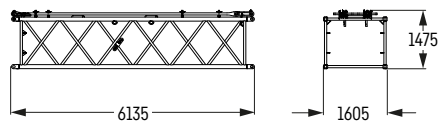
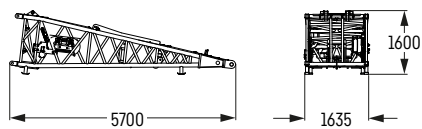
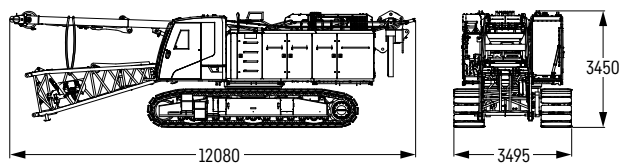
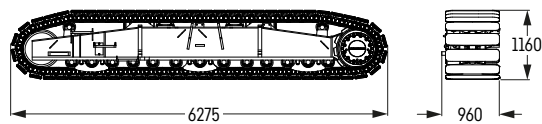
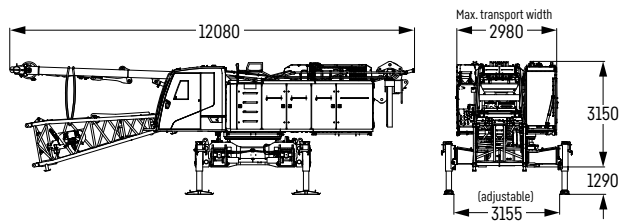

Basic machine

Weight without hoist rope	kg	32500
Weight of hoist ropes	kg/m	3.4

with A-frame 1, winches 1 + 2 (2x 120 kN), with boom foot, with telescopic jack-up cylinders, without rear counterweight, without carbody counterweight, without detachable crawler side frames

Crawler side frame

Weight flat track pads 900 mm	kg	8000
-------------------------------	----	------

Transport option – basic machine

Weight without hoist rope	kg	45100
Weight of hoist ropes	kg/m	3.4

with A-frame 1, winches 1 + 2 (2x 120 kN), with boom foot, with non-detachable crawler side frames, without rear counterweight, without carbody counterweight

Boom foot 5.5 m (No. 1512.21)

Weight	kg	1320
--------	----	------

Boom section 6 m (No. 1512.21)

Weight including pendants	kg	777
---------------------------	----	-----

Boom section 12 m (No. 1512.21)

Weight including pendants	kg	1428
---------------------------	----	------

Boom head 8.5 m (No. 1512.21)

Weight including pendants	kg	1305
---------------------------	----	------

Auxiliary jib

Weight	kg	716
--------	----	-----

Fixed jib 0806.21

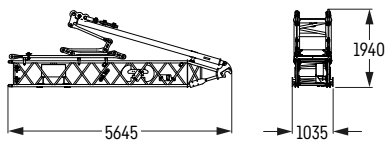
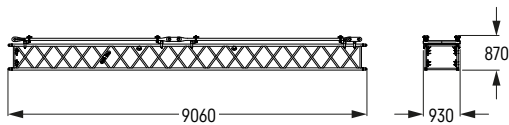
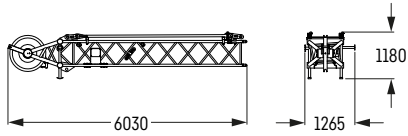

Jib head 5.5 m (No. 0806.21)

Weight including pendants	kg 672
---------------------------	--------

Jib section 9 m (No. 0806.21)

Weight including pendants	kg 577
---------------------------	--------

Jib foot 5.5 m with A-frame (No. 0806.21)

Weight including pendants	kg 961
---------------------------	--------

Counterweight

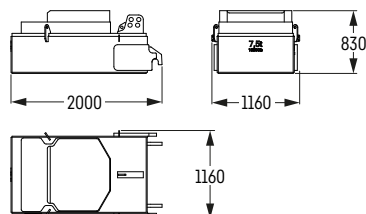
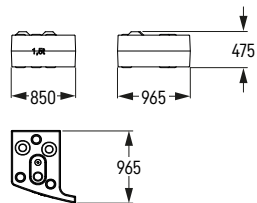
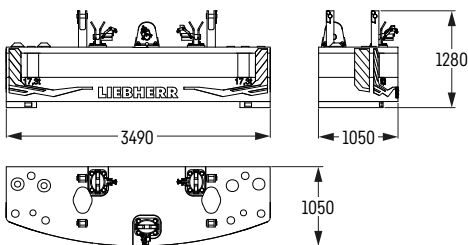

Basic counterweight slab without tie-down (1x)

Weight	kg 17300
--------	----------

Counterweight slab (8x, option: 10x)

Weight	kg 1500
--------	---------

Carbody counterweight slab (2x)

Weight	kg 7500
Weight (option)	kg 9500

Pulley block with additional weights / load hooks

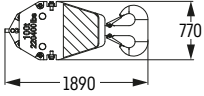

100 t pulley block - 5 pulleys

Width	mm 745
Weight	kg 1300 / 1800 / 2300

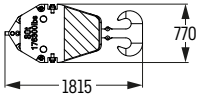

80 t pulley block - 3 pulleys

Width	mm 565
Weight	kg 1000 / 1500 / 2000

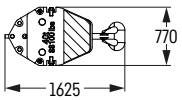

40 t pulley block - 1 pulley

Width	mm 490
Weight	kg 700 / 1100 / 1500

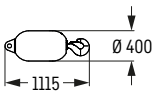

12.5 t load hook

Weight	kg 600
--------	--------

Self-assembly system

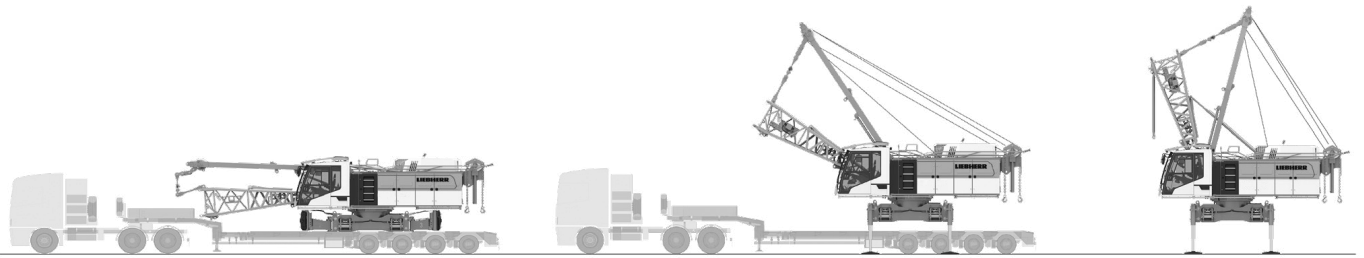

Unloading of basic machine (option)

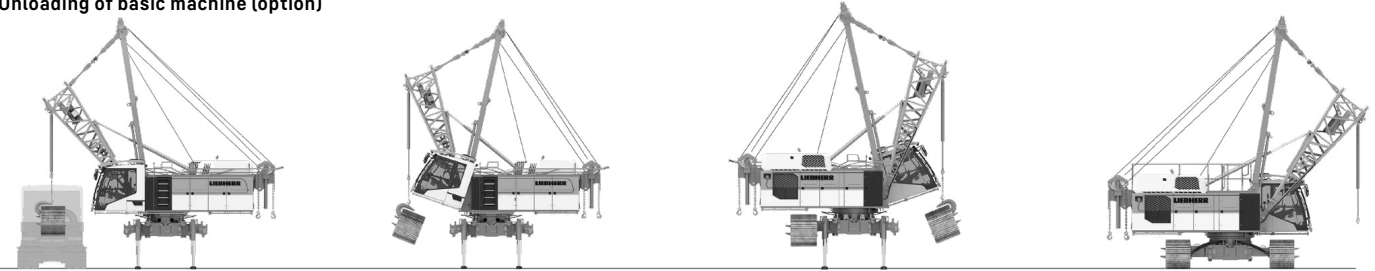

Unloading and assembly of crawler side frames

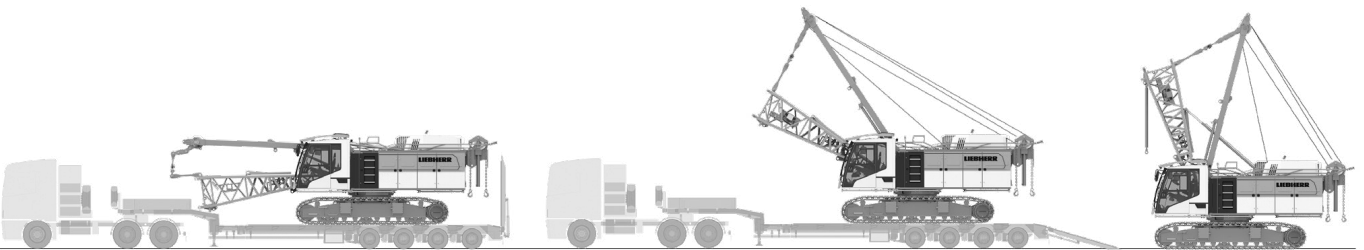

Unloading of basic machine (standard)

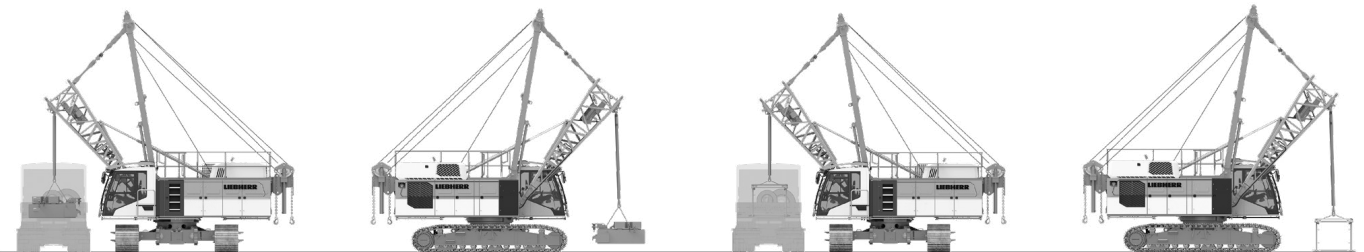

Unloading and assembly of carbody counterweight

Unloading and assembly of boom

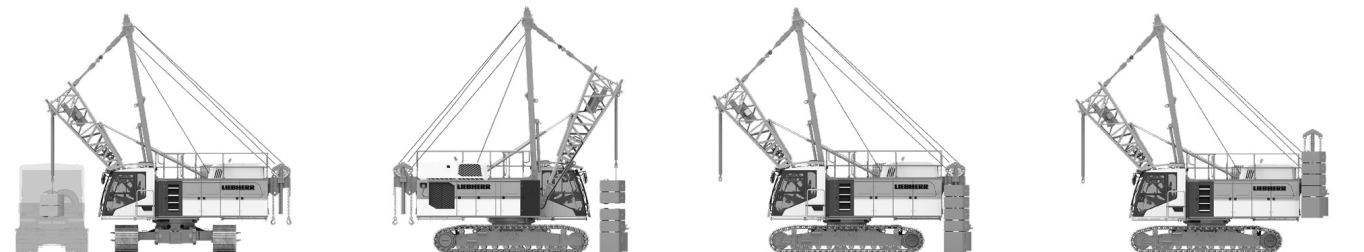

Unloading and assembly of rear counterweight

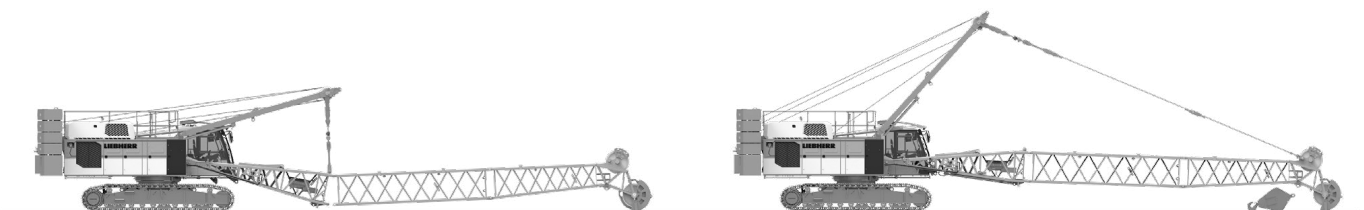

Assembly of boom and reeving of hoist ropes

Boom combinations

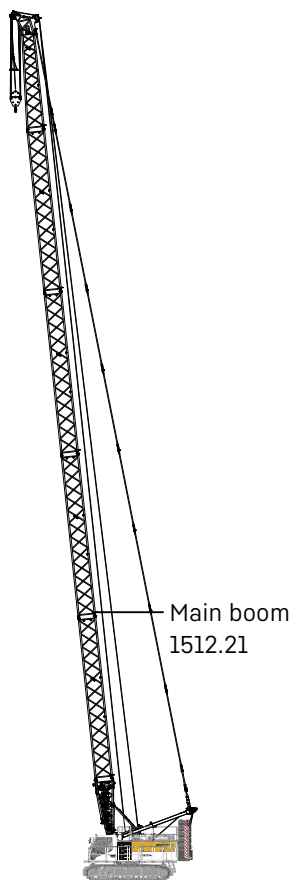

Main boom

Mode 1

Max. length

1512.21 m 62

Further information on page 14.

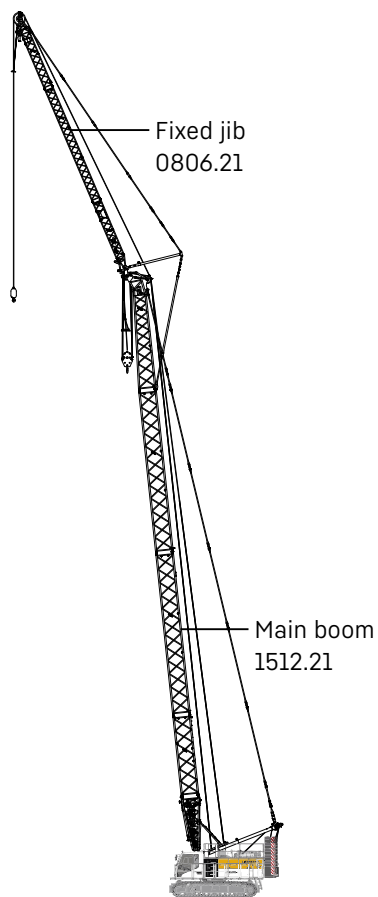

Main boom + fixed jib

Mode 3

Max. combination

1512.21 m 44

0806.21 m 20

Total length m 64

Further information on page 16.

Main boom 1512.21

Boom lengths 14-62 m

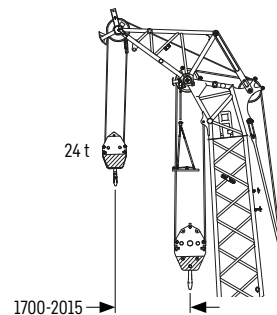
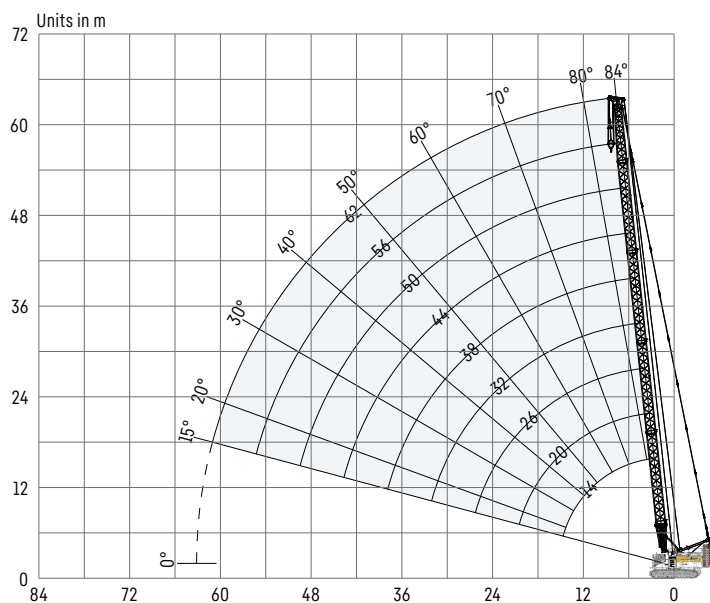

Auxiliary jib 24 t (option)

The maximum capacity of the auxiliary jib is 24 t. The corresponding load chart is programmed in the LML system.

Main boom configuration 1512.21

Boom section	Amount of boom sections								
	14	20	26	32	38	44	50	56	62
Boom foot 5.5 m	1	1	1	1	1	1	1	1	1
Boom section 6 m		1		1		1		1	
Boom section 12 m			1	1	2	2	3	3	4
Boom head 8.5 m	1	1	1	1	1	1	1	1	1
Boom length [m]	14	20	26	32	38	44	50	56	62
Auxiliary jib	✓	✓	✓	✓	✓	✓	✓	✓	✓

Load capacities with main boom

Load capacities in [t]

	Boom length [m]																	
	14		20		26		32		38		44		50		56		62	
	(S)	(O)	(S)	(O)	(S)	(O)	(S)	(O)	(S)	(O)	(S)	(O)	(S)	(O)	(S)	(O)	(S)	(O)
3.3	100.0	100.0																
4	94.2	96.9	87.5	88.7														
5	74.6	78.4	71.2	74.8	64.6	70.2												
6	62.0	65.0	57.6	62.7	53.1	57.8	49.1	53.4	45.6	49.2								
7	48.9	53.2	48.3	52.6	45.0	49.0	41.9	45.7	39.2	42.8	36.7	38.1						
8	40.3	43.9	40.3	43.9	38.9	42.4	36.5	39.8	34.3	37.5	32.3	35.2	26.6	26.6	20.0	20.0		
9	34.2	37.2	34.2	37.2	34.1	37.2	32.3	35.2	30.5	33.3	28.8	31.5	24.9	24.9	19.1	19.1	13.4	13.4
10	29.6	32.3	29.6	32.3	29.5	32.2	28.9	31.5	27.3	29.9	25.8	28.3	23.5	23.5	18.0	18.0	12.5	12.5
11	26.0	28.4	26.0	28.4	26.0	28.3	25.8	28.2	24.7	27.0	23.4	25.7	22.0	22.0	16.9	16.9	11.8	11.8
12	23.2	25.3	23.2	25.4	23.1	25.2	23.0	25.1	22.5	24.7	21.4	23.5	20.3	20.8	15.8	15.8	11.1	11.1
13	20.9	22.8	20.9	22.8	20.8	22.7	20.6	22.6	20.5	22.4	19.6	21.6	18.6	19.7	15.0	15.0	10.3	10.3
14	18.9	20.7	19.0	20.8	18.9	20.6	18.7	20.5	18.5	20.3	18.1	19.9	17.2	18.5	14.3	14.3	9.7	9.7
15			17.4	19.0	17.2	18.9	17.1	18.7	16.9	18.5	16.7	18.3	15.9	17.5	13.5	13.5	9.2	9.2
16			16.0	17.5	15.9	17.4	15.7	17.2	15.5	17.0	15.3	16.8	14.8	16.4	12.7	12.7	8.7	8.7
17			14.7	16.2	14.6	16.1	14.5	15.9	14.3	15.7	14.1	15.5	13.8	15.3	12.0	12.0	8.2	8.2
18			13.7	15.0	13.6	14.9	13.4	14.7	13.2	14.6	13.0	14.3	12.8	14.1	11.4	11.4	7.7	7.7
19			12.7	14.0	12.7	13.9	12.5	13.7	12.3	13.5	12.1	13.3	11.9	13.1	10.9	10.9	7.3	7.3
20			11.9	13.0	11.9	13.0	11.7	12.8	11.5	12.6	11.3	12.4	11.0	12.2	10.4	10.4	6.9	6.9
21					11.1	12.2	11.0	12.1	10.8	11.9	10.5	11.6	10.3	11.4	9.9	9.9	6.6	6.6
22					10.4	11.5	10.3	11.3	10.1	11.2	9.9	10.9	9.6	10.7	9.4	9.5	6.3	6.3
24					9.3	10.2	9.1	10.1	8.9	9.9	8.7	9.7	8.5	9.4	8.2	8.6	5.6	5.6
25					8.8	9.7	8.6	9.5	8.4	9.4	8.2	9.1	8.0	8.9	7.7	8.2	5.4	5.4
26					8.3	9.2	8.2	9.0	8.0	8.8	7.8	8.6	7.5	8.4	7.3	7.9	5.1	5.1
27							7.7	8.6	7.5	8.4	7.3	8.2	7.1	7.9	6.8	7.6	4.8	4.8
28							7.3	8.1	7.2	8.0	6.9	7.7	6.7	7.5	6.4	7.3	4.6	4.6
30							6.6	7.4	6.4	7.2	6.2	7.0	6.0	6.8	5.7	6.5	4.2	4.2
31							6.3	7.0	6.1	6.9	5.9	6.6	5.7	6.4	5.4	6.2	4.1	4.1
32							6.0	6.7	5.8	6.5	5.6	6.3	5.4	6.1	5.1	5.8	4.0	4.0
33									5.6	6.2	5.4	6.0	5.1	5.8	4.9	5.5	4.0	4.0
34									5.3	6.0	5.1	5.8	4.9	5.5	4.6	5.3	3.9	3.9
35									5.0	5.7	4.8	5.5	4.6	5.3	4.4	5.0	3.8	3.8
36									4.8	5.4	4.6	5.2	4.4	5.0	4.2	4.8	3.7	3.7
38									4.4	5.0	4.2	4.8	4.0	4.6	3.7	4.3	3.4	3.6
39											4.0	4.6	3.8	4.4	3.5	4.1	3.2	3.5
40											3.8	4.4	3.6	4.2	3.3	3.9	3.0	3.4
42											3.4	4.0	3.2	3.8	2.9	3.5	2.6	3.2
43											3.3	3.8	3.0	3.6	2.8	3.3	2.5	3.0
44											3.1	3.6	2.9	3.4	2.6	3.1	2.3	2.8
45													2.7	3.2	2.4	3.0	2.2	2.7
46													2.6	3.1	2.3	2.8	2.0	2.5
47													2.4	2.9	2.2	2.7		2.4
48													2.3	2.8	2.0	2.5		2.2
49													2.2	2.6		2.4		2.1
50																2.2		
51																2.1		

Carbody counterweight: (S) standard 15.3 t, (O) option 19.2 t

Rear counterweight:

23.3 t	
26.3 t	option
29.3 t	32.3 t



TLT 13669693 0 V6. Above load charts are for reference only. For actual lift duty please refer to load chart in operator's cabin or manual. Otherwise we recommend you to plan your lifting job using Crane Planner 2.0.

www.liebherr.com/CranePlanner



Fixed jib 0806.21

Jib lengths 11-20 m

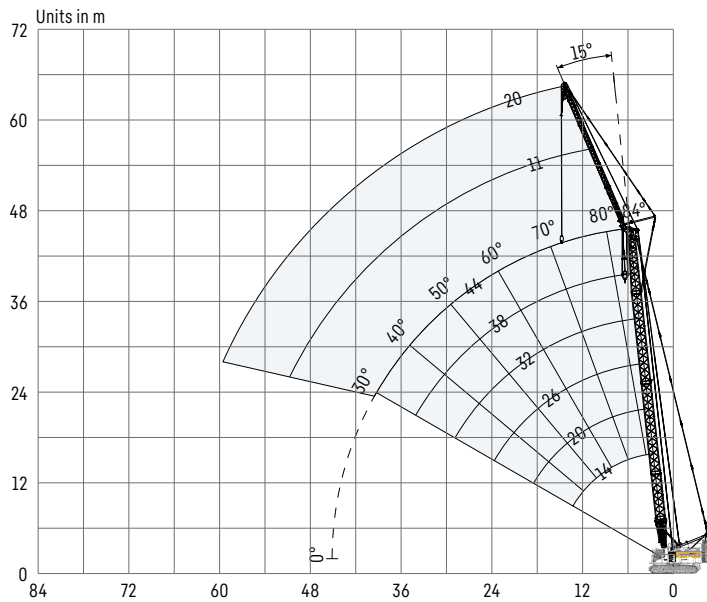

Jib configuration 0806.21

Jib section	Amount of jib sections	
Jib foot 5.5 m	1	1
Jib section 9 m		1
Jib head 5.5 m	1	1
Jib length [m]	11	20

For main boom configuration please refer to the table on page 14.

Load capacities with fixed jib

Load capacities in [t] with 14 m main boom

	Jib length 11 m		Jib length 20 m	
	(S)	(O)	(S)	(O)
6.4	20.0	20.0		
7	20.0	20.0		
8	20.0	20.0		
9	20.0	20.0		
10	20.0	20.0	10.6	10.6
11	19.5	19.5	10.2	10.2
12	18.7	18.7	9.8	9.8
13	18.0	18.0	9.4	9.4
14	17.3	17.3	9.1	9.1
15	16.5	16.5	8.9	8.9
16	15.9	15.9	8.7	8.7
17	14.7	15.3	8.5	8.5
18	13.6	14.3	8.4	8.4
19	12.6	13.5	8.0	8.0
20	11.8	12.7	7.7	7.7
21	11.1	12.1	7.4	7.4
22	10.4	11.4	7.2	7.2
23	9.7	10.8	7.0	7.0
24	9.2	10.1	6.8	6.8
25	8.6	9.5	6.7	6.7
26			6.6	6.6
27			6.5	6.5
28			6.4	6.4
29			6.3	6.3
30			6.2	6.2
31			6.2	6.2
32			6.1	6.1
33			6.0	6.0
34				
35				
36				
37				
38				
39				
40				
41				
42				
43				
44				

Load capacities in [t] with 20 m main boom

	Jib length 11 m		Jib length 20 m	
	(S)	(O)	(S)	(O)
6.4				
7	20.0	20.0		
8	20.0	20.0		
9	19.8	19.8		
10	19.1	19.1	10.4	10.4
11	18.2	18.2	10.1	10.1
12	17.6	17.6	9.8	9.8
13	16.8	16.8	9.5	9.5
14	16.1	16.1	9.2	9.2
15	15.5	15.5	9.0	9.0
16	15.0	15.0	8.8	8.8
17	14.4	14.4	8.6	8.6
18	13.4	14.0	8.4	8.4
19	12.4	13.6	8.2	8.2
20	11.6	12.7	8.1	8.1
21	10.8	11.9	7.9	7.9
22	10.2	11.2	7.7	7.7
23	9.5	10.5	7.4	7.4
24	9.0	9.9	7.2	7.2
25	8.4	9.4	7.1	7.1
26	8.0	8.8	6.9	6.9
27	7.5	8.4	6.8	6.8
28	7.1	7.9	6.7	6.7
29	6.7	7.5	6.6	6.6
30	6.4	7.1	6.5	6.5
31		7.1	6.3	6.4
32			6.0	6.3
33			5.8	6.2
34			5.5	6.1
35			5.2	5.8
36			5.0	5.6
37			4.8	5.4
38			4.5	5.1
39				
40				
41				
42				
43				
44				

Load capacities in [t] with 26 m main boom

	Jib length 11 m		Jib length 20 m	
	(S)	(O)	(S)	(O)
6.4				
7				
8	18.7	18.7		
9	17.9	17.9		
10	17.1	17.1	10.3	10.3
11	16.4	16.4	10.1	10.1
12	15.8	15.8	9.8	9.8
13	15.2	15.2	9.5	9.5
14	14.7	14.7	9.3	9.3
15	14.1	14.1	9.0	9.0
16	13.6	13.6	8.7	8.7
17	13.2	13.2	8.5	8.5
18	12.9	12.9	8.4	8.4
19	12.2	12.5	8.2	8.2
20	11.4	12.1	8.0	8.0
21	10.6	11.7	7.8	7.8
22	9.9	11.0	7.7	7.7
23	9.3	10.3	7.5	7.5
24	8.7	9.7	7.3	7.3
25	8.2	9.1	7.1	7.1
26	7.7	8.6	6.9	6.9
27	7.3	8.2	6.8	6.8
28	6.9	7.7	6.6	6.6
29	6.5	7.3	6.5	6.5
30	6.2	6.9	6.3	6.3
31	5.8	6.6	6.1	6.2
32	5.5	6.2	5.8	6.0
33	5.2	5.9	5.5	5.8
34	5.0	5.6	5.2	5.7
35	4.7	5.3	5.0	5.6
36			4.8	5.3
37			4.5	5.1
38			4.3	4.9
39			4.1	4.7
40			3.9	4.5
41			3.7	4.3
42			3.5	4.1
43			3.4	3.9
44			3.2	3.7

Carbody counterweight: (S) standard 15.3 t, (O) option 19.2 t

Rear counterweight:

	option
29.3 t	32.3 t

TLT 13669693 0 V6. Above load charts are for reference only. For actual lift duty please refer to load chart in operator's cabin or manual. Otherwise we recommend you to plan your lifting job using Crane Planner 2.0.



www.liebherr.com/CranePlanner

Crane Planner 2.0

Load capacities with fixed jib

Load capacities in [t] with 32 m main boom

	Jib length 11 m		Jib length 20 m	
	(S)	(O)	(S)	(O)
8	17.5	17.5		
9	16.8	16.8		
10	16.1	16.1		
11	15.6	15.6	9.8	9.8
12	15.1	15.1	9.5	9.5
13	14.5	14.5	9.2	9.2
14	14.0	14.0	8.9	8.9
15	13.7	13.7	8.7	8.7
16	13.2	13.2	8.5	8.5
17	12.8	12.8	8.3	8.3
18	12.5	12.5	8.2	8.2
19	12.0	12.2	8.1	8.1
20	11.1	11.9	7.8	7.8
21	10.4	11.5	7.6	7.6
22	9.7	10.7	7.4	7.4
23	9.1	10.1	7.2	7.2
24	8.5	9.5	7.1	7.1
25	8.0	8.9	7.0	7.0
26	7.5	8.4	6.8	6.8
27	7.1	7.9	6.6	6.6
28	6.7	7.5	6.5	6.5
29	6.3	7.1	6.3	6.3
30	5.9	6.7	6.2	6.2
31	5.6	6.3	5.8	6.1
32	5.3	6.0	5.6	6.0
33	5.0	5.7	5.3	5.9
34	4.7	5.4	5.0	5.6
35	4.5	5.1	4.8	5.4
36	4.2	4.9	4.5	5.1
37	4.0	4.6	4.3	4.9
38	3.8	4.4	4.1	4.6
39	3.6	4.2	3.9	4.4
40	3.4	3.9	3.7	4.2
41			3.5	4.0
42			3.3	3.8
43			3.1	3.6
44			2.9	3.5

Load capacities in [t] with 38 m main boom

	Jib length 11 m		Jib length 20 m	
	(S)	(O)	(S)	(O)
8				
9	16.0	16.0		
10	15.5	15.5		
11	14.9	14.9	9.2	9.2
12	14.5	14.5	9.0	9.0
13	14.1	14.1	8.8	8.8
14	13.6	13.6	8.5	8.5
15	13.2	13.2	8.3	8.3
16	12.9	12.9	8.1	8.1
17	12.6	12.6	7.9	7.9
18	12.2	12.2	7.8	7.8
19	11.8	11.9	7.6	7.6
20	10.9	11.6	7.5	7.5
21	10.2	11.2	7.4	7.4
22	9.5	10.5	7.2	7.2
23	8.9	9.9	7.0	7.0
24	8.3	9.2	6.8	6.8
25	7.8	8.7	6.6	6.6
26	7.3	8.2	6.5	6.5
27	6.8	7.7	6.4	6.4
28	6.4	7.2	6.3	6.3
29	6.0	6.8	6.2	6.2
30	5.7	6.4	5.9	6.1
31	5.4	6.1	5.6	6.0
32	5.1	5.8	5.3	5.9
33	4.8	5.4	5.0	5.7
34	4.5	5.2	4.8	5.4
35	4.2	4.9	4.5	5.2
36	4.0	4.6	4.3	4.9
37	3.8	4.4	4.0	4.6
38	3.5	4.2	3.8	4.4
39	3.3	3.9	3.6	4.2
40	3.1	3.7	3.4	4.0
41	2.9	3.5	3.2	3.8
42	2.7	3.3	3.0	3.6
43	2.6	3.1	2.8	3.4
44	2.4	2.9	2.7	3.2

Carbody counterweight: (S) standard 15.3 t, (O) option 19.2 t

Rear counterweight:

	option
29.3 t	32.3 t

TLT 13669693 0 V6. Above load charts are for reference only. For actual lift duty please refer to load chart in operator's cabin or manual. Otherwise we recommend you to plan your lifting job using Crane Planner 2.0.

Load capacities with fixed jib

Load capacities in [t] with 44 m main boom

	Jib length 11 m		Jib length 20 m	
	(S)	(O)	(S)	(O)
8				
9	15.1	15.1		
10	14.7	14.7		
11	14.3	14.3		
12	13.8	13.8	8.5	8.5
13	13.5	13.5	8.3	8.3
14	13.2	13.2	8.1	8.1
15	12.8	12.8	7.9	7.9
16	12.5	12.5	7.7	7.7
17	12.2	12.2	7.6	7.6
18	12.0	12.0	7.4	7.4
19	11.2	11.6	7.2	7.2
20	10.4	11.3	7.0	7.0
21	9.8	10.9	6.9	6.9
22	9.2	10.3	6.8	6.8
23	8.6	9.6	6.6	6.6
24	8.0	9.0	6.5	6.5
25	7.5	8.4	6.4	6.4
26	7.0	7.9	6.3	6.3
27	6.6	7.4	6.2	6.2
28	6.2	7.0	6.2	6.2
29	5.8	6.6	6.0	6.1
30	5.5	6.2	5.6	6.0
31	5.1	5.8	5.4	5.8
32	4.8	5.5	5.1	5.7
33	4.5	5.2	4.8	5.4
34	4.3	4.9	4.5	5.2
35	4.0	4.6	4.3	4.9
36	3.7	4.4	4.0	4.6
37	3.5	4.1	3.8	4.4
38	3.3	3.9	3.6	4.2
39	3.0	3.6	3.3	3.9
40	2.8	3.4	3.1	3.7
41	2.6	3.2	2.9	3.5
42	2.4	3.0	2.7	3.3
43	2.3	2.8	2.6	3.1
44	2.1	2.6	2.4	2.9

Load capacities in [t] with 50 m main boom

	Jib length 11 m
	(O)
8	
9	14.0
10	13.8
11	13.5
12	13.0
13	12.5
14	12.1
15	11.8
16	11.3
17	10.9
18	10.6
19	10.3
20	10.1
21	9.8
22	9.5
23	9.1
24	8.5
25	8.1
26	7.6
27	7.2
28	6.7
29	6.3
30	6.0
31	5.6
32	5.3
33	5.0
34	4.7
35	4.4
36	4.1
37	3.8
38	3.6
39	3.4
40	3.2
41	2.9
42	2.7
43	2.5
44	2.4

Carbody counterweight: (S) standard 15.3 t, (O) option 19.2 t

Rear counterweight:

	option
29.3 t	32.3 t

TLT 13669693 0 V6. Above load charts are for reference only. For actual lift duty please refer to load chart in operator's cabin or manual. Otherwise we recommend you to plan your lifting job using Crane Planner 2.0.



Download datasheet



Please contact us.

Liebherr-Werk Nenzing GmbH · Dr. Hans Liebherr Str. 1 · 6710 Nenzing, Austria
Phone +43 50809 41-473 · crawler.crane@liebherr.com · www.liebherr.com
facebook.com/LiebherrConstruction