

EN

LR 1400 SX

LR 1007.01.08
www.liebherr.com

LIEBHERR

Crawler cranes



Concept and characteristics	3
Technical description	8
Dimensions	10
Transport dimensions and weights	11
Self-assembly system	18
Boom combinations	20
Main boom 2825.xx	22
Luffing jib 2421.xx	24
Luffing jib 2316.xx	30
Fixed jib 1507.20	36
Fixed jib 1916.xx	38
Fixed jib 1713.xx	40
Notes	42

Remarks

- The load capacities stated are valid for lifting operation only (corresponding with crane classification according to ISO 4301-1, crane group A1).
- Machine is standing on firm, horizontal ground.
- The weight of the lifting device (pulley block, hoist ropes, shackles etc.) must be deducted from the load capacity.
- Additional equipment on boom (e.g. walkways) must be deducted from the load capacity.
- The max. admissible wind speed can be preselected in the LML software and referred to in the load chart.
- Working radii are measured from centre of swing and under load.
- The lifting capacities are valid for 360 degrees of swing.
- Calculation of stability under load was carried out according to ISO 4305 Table 1 + 2 + 3, tipping angle 4°, as well as ANSI/ASME B 30.5 and was tested according to SAE J765 and SAE J987.
- The structures are calculated according to EN 13001-1; EN 13001-2.
- The last digits of the given dimensions are rounded to 0 and 5 and may differ from the actual dimensions.
- Weights may vary depending on the delivered configuration of the machine filling level of the tanks as well as generally valid tolerances.
- The figures in this brochure may include options which are not within the standard scope of supply of the machine.
- Subject to technical change without notice.

Concept and characteristics

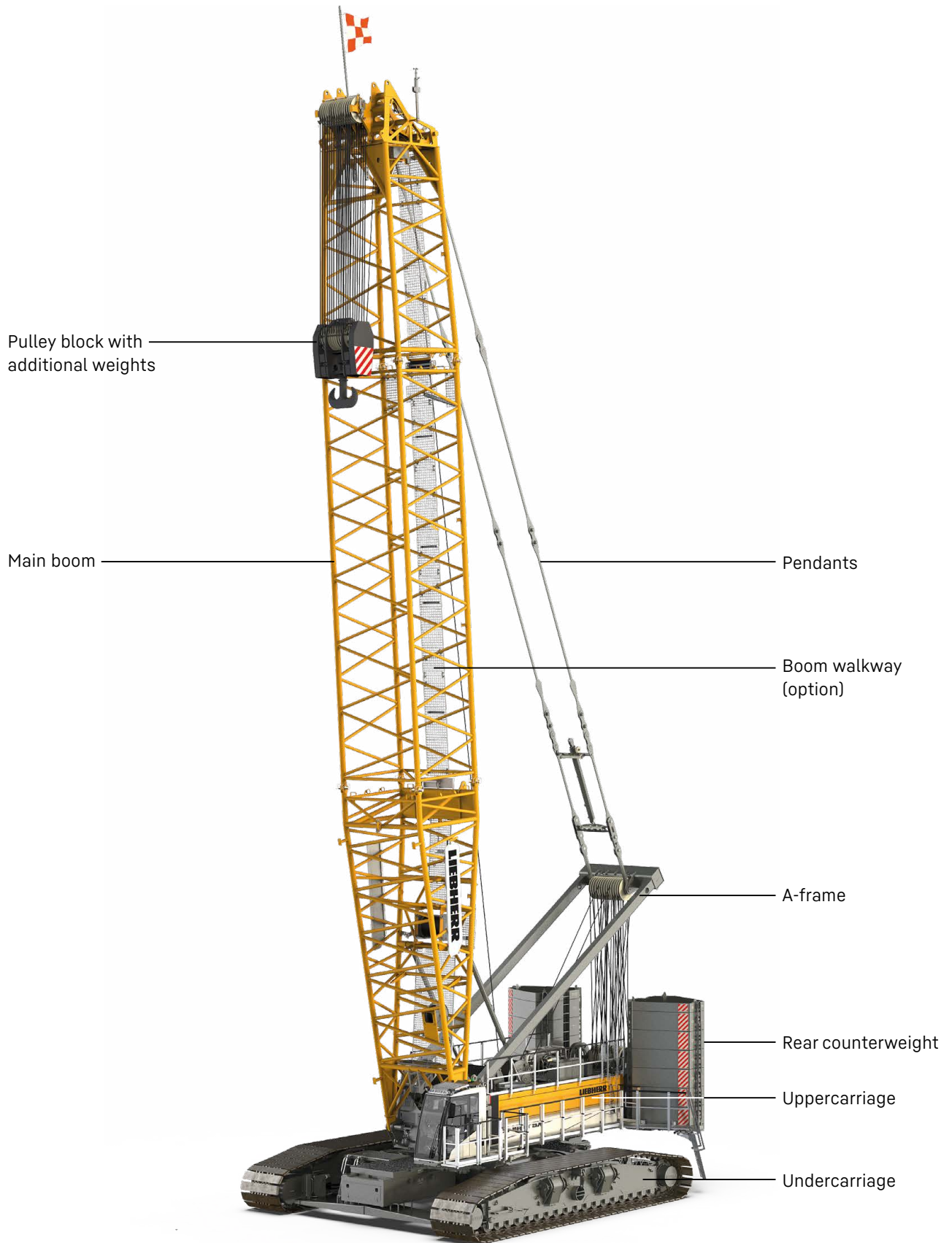

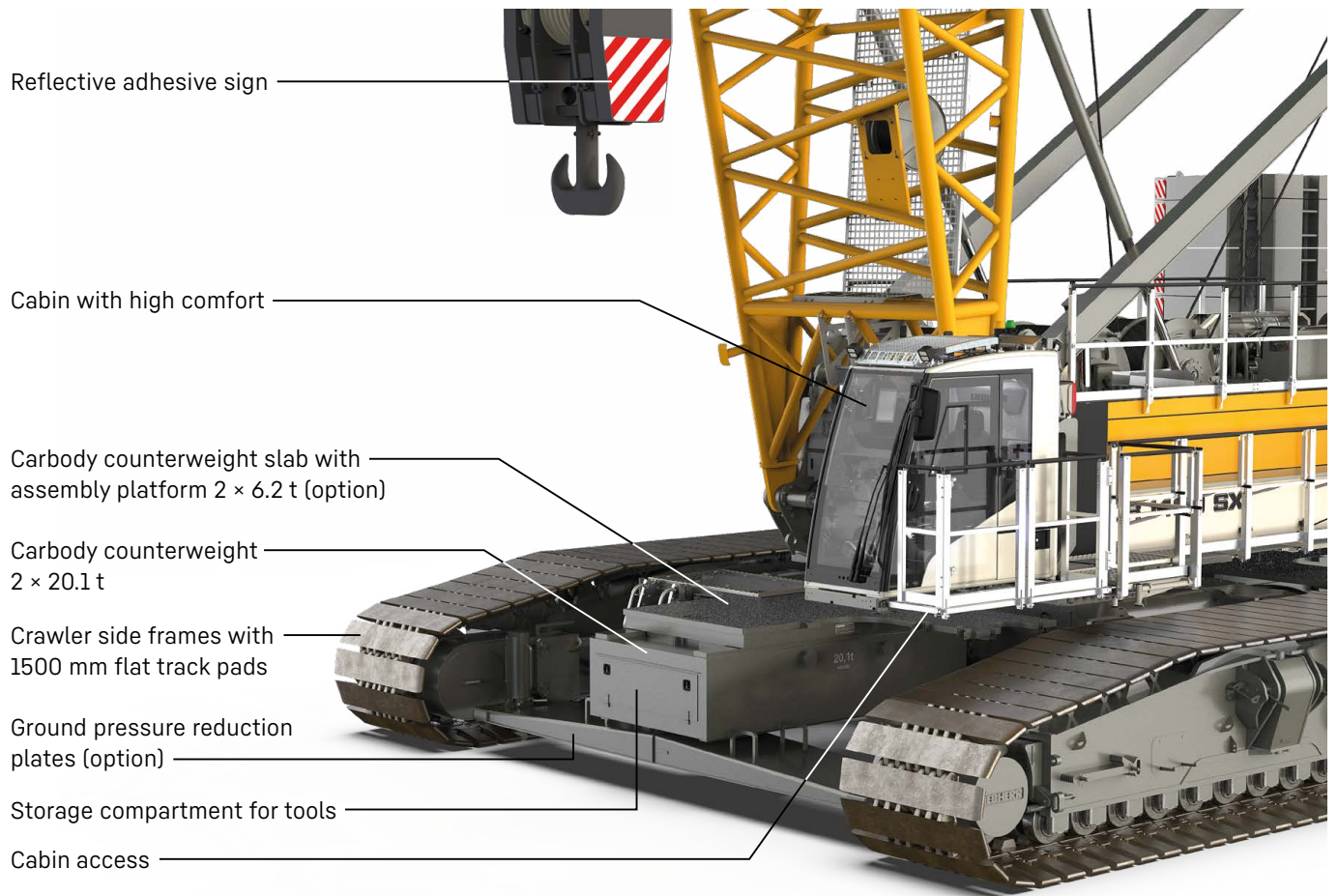

High performance

A strong, efficient and reliable diesel engine of the newest generation provides high performance and enables several movements to be carried out simultaneously.

Cabin with high comfort

Optimised field of vision combined with enhanced comfort: an orthopaedic operator's seat with heating and cooling functions, as well as precise and ergonomic controls are included. Air conditioning is optional.

Ground pressure

The actual ground pressure is calculated according to the configuration and position of the machine and displayed in the operator's cabin. Using the optional Liebherr Crane Planner 2.0 the actual ground pressure can already be calculated and displayed in the planning stage.

Control system

Easy and intuitive handling of control, service and machine functions through a large, clear colour monitor. Built for extreme environmental conditions.

Travelling with load

By preselecting one of the three travel speeds, the control automatically applies the permitted load curve.

Stage 1: up to 0.1 m/s

Stage 2: up to 0.4 m/s

Stage 3: more than 0.4 m/s

Barge operation

By preselecting the barge inclination the control automatically applies the permitted load curve.

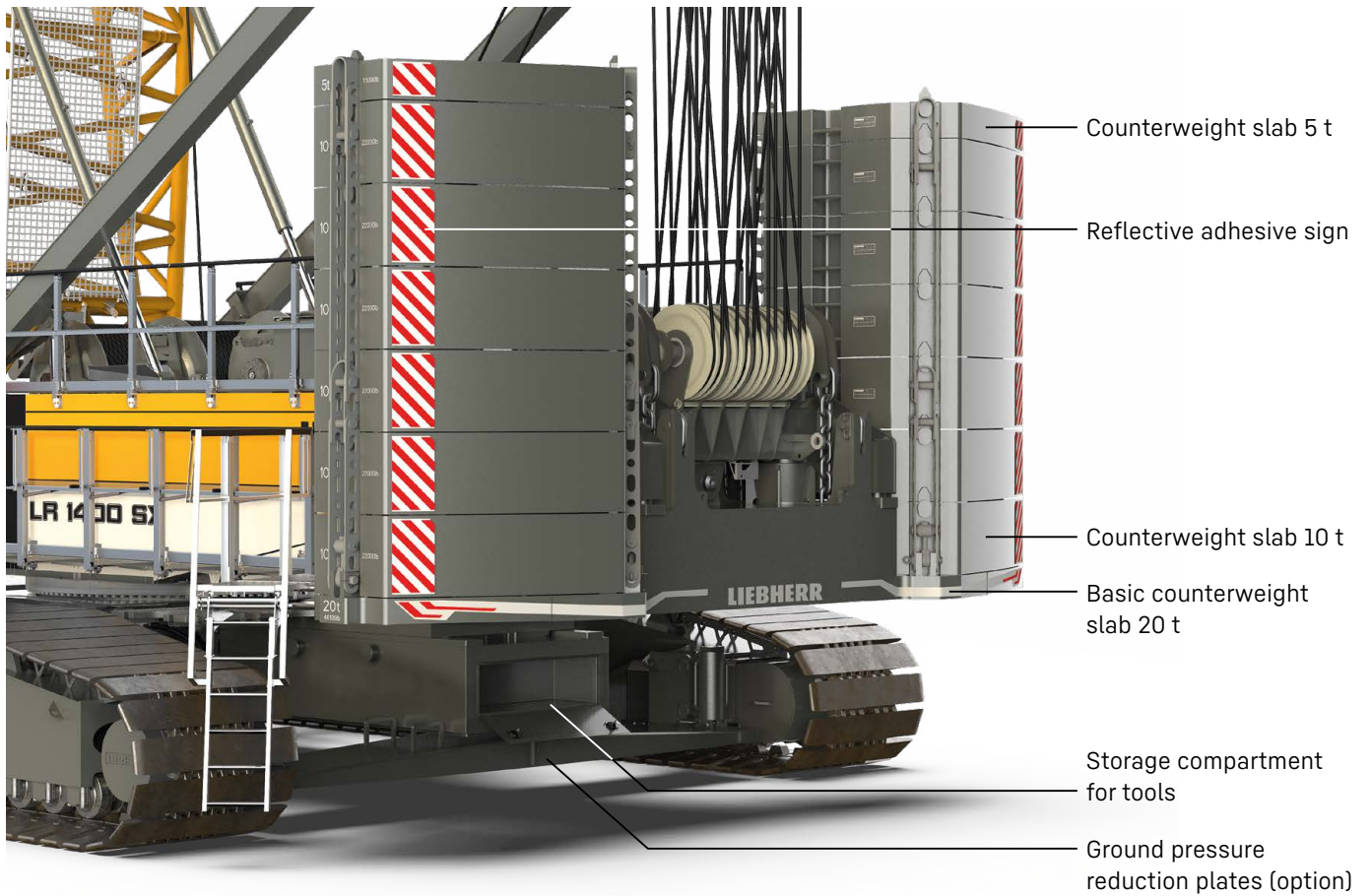

Efficient self-assembly system and short assembly times

The optional self-assembly system enables safe, independent and quick assembly/disassembly of the crawler side frames, the carbody and rear counterweights, the two hoist winches, as well as boom elements.

Easy service

The design ensures easy maintenance and service as well as safe access to the components.

Mobility

Crane parts are optimized for transportation. The maximum transport width is 3 m.

Boom/jib

A variety of boom systems and configurations allow for optimum operation on the most diverse jobsites.

Reduction of ground pressure (option)

With the help of the new hydraulically activated ground pressure reduction plates, the ground pressure can be reduced by up to 56 %.

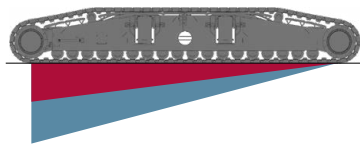
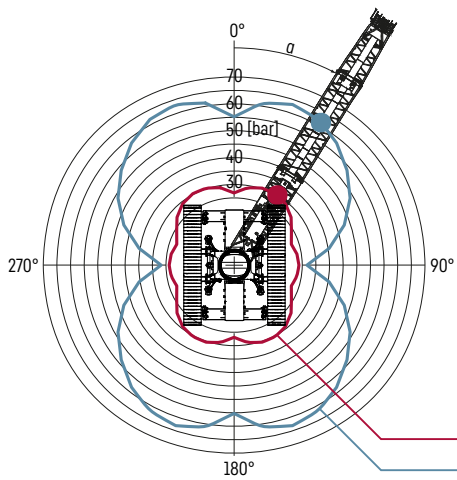

with ground pressure reduction plates
without ground pressure reduction plates

Ground pressure reduction plates

Quick assembly of hoisting winches

Winch installation and removal can be carried out within seconds thanks to the integrated self-adjustment in the winch frame, as well as the hands-free quick connect, which has been used for many years in the toughest of applications.

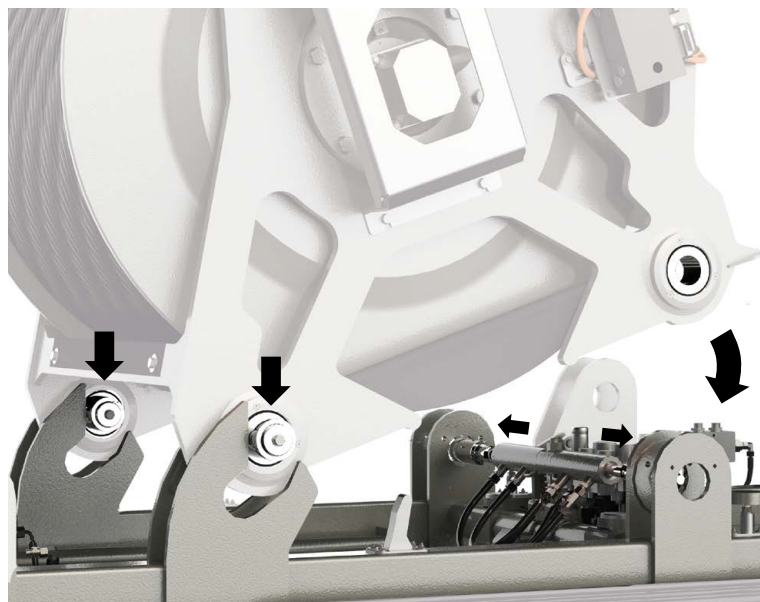
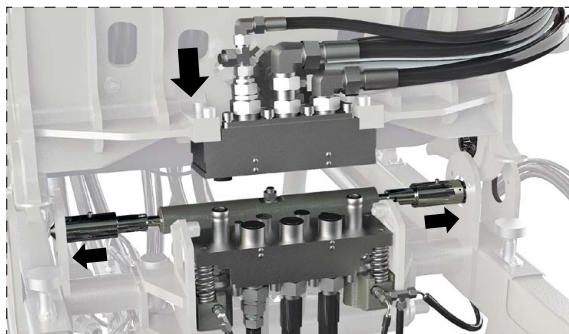

The winch guides and locks itself during installation.

Cabin access

Safe and non-slip direct access to the cabin is via convenient foldable steps and continues on illuminated platforms. For the first time, access is no longer via the track pads, thus we fulfil the highest possible safety standard.

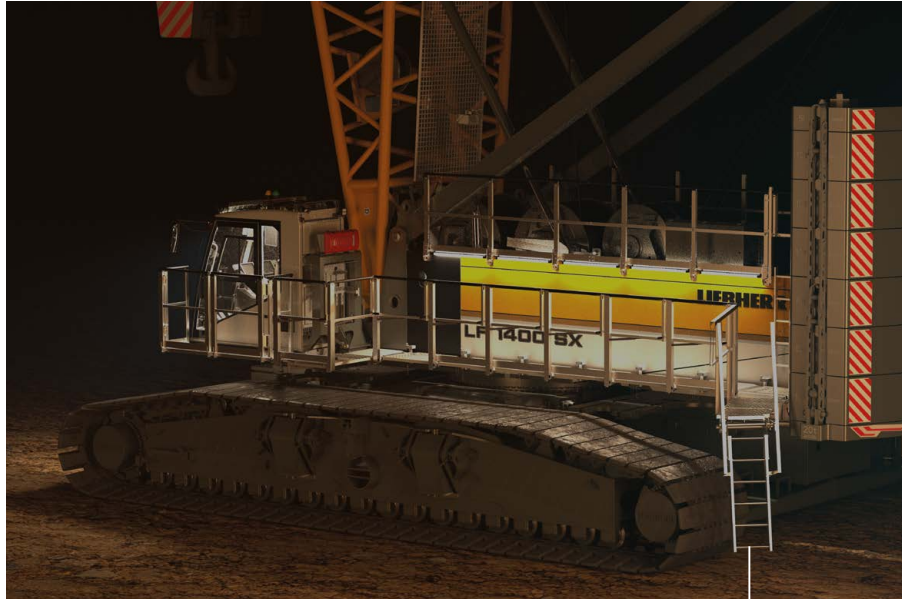

Convenient foldable steps

Preselection of customised load curves

Different wind speeds. The driver can preselect appropriate and permitted load curves for different wind speeds by pressing a button directly on the monitor.

In the same way different barge inclinations or travel speeds, or even "grab operation" and further operation modes can be selected. In all cases the control system automatically assigns an appropriate permitted load curve.

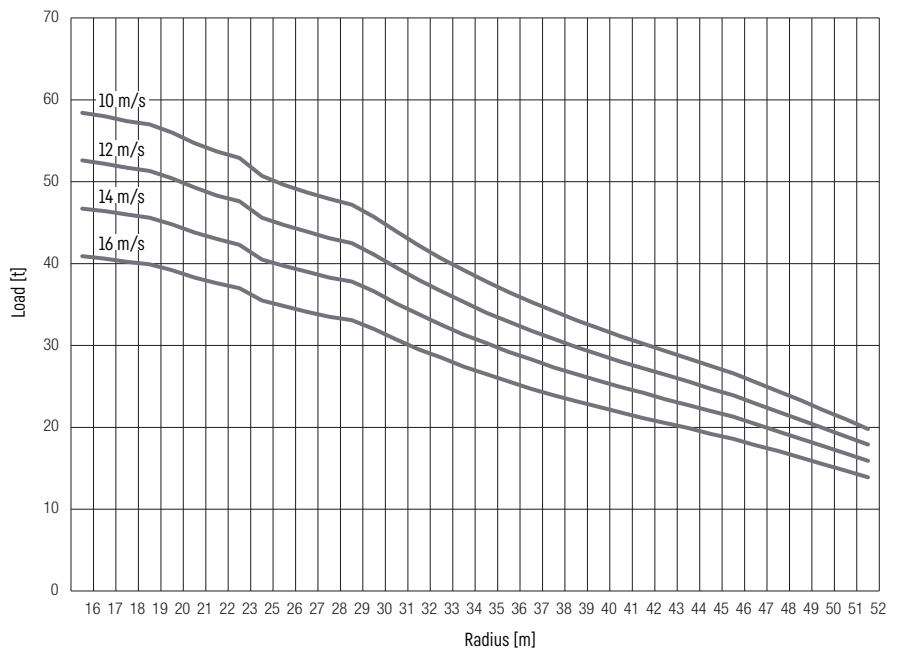

The above diagram shows an example of the selectable load curves for different wind speeds.

Technical description



Diesel engine

Power rating according to ISO 9249	450 kW (603 hp) at 1700 rpm
Engine type	Liebherr D 966 A7-05
Fuel tank capacity	805 l with continuous level indicator and reserve warning
Exhaust certification	Version 1: 97/68 EC Stage V and EPA/CARB Tier 4f Version 2: EPA/CARB Tier 4f Version 3: without certified emission standard



Noise measurement data and vibration

Noise emission	according to 2000/14/EC directive	
Emission sound pressure level L_{PA}	69 dB(A)	(in the cabin)
Guaranteed sound power level L_{WA}	107 dB(A)	(of the machine)
Vibration transmitted to the machine operator	< 2.5 m/s ² (to the hand-arm system) < 0.5 m/s ² (to the whole body)	



Hydraulic system

Hydraulic pumps	double axial displacement pump in closed loop hydraulic system allows all functions to be operated simultaneously automatic working pressure cut-off to minimize peak pressure
Hydraulic oil tank capacity	680 l
Max. working pressure	350 bar
Hydraulic oil	electronic monitoring of all filters use of synthetic environmentally friendly oil



Control

Control system	includes all control and monitoring functions, designed to withstand extreme environmental conditions and heavy construction tasks
Display	colour touchscreen in the operator's cabin, clear display of complete machine operating data, warnings and failure indications in the required language
Operation	several movements can be performed simultaneously thanks to electro-hydraulic proportional control, all categories of loads can be positioned with utmost precision



Crawlers

Drive system	with variable displacement axial piston motors, four drives
Crawler side frames	manual chain tensioning
Brake	hydraulically released, spring-loaded multi-disc holding brake
Drive speed	0-1.3 km/h
Flat track pads	Width 1500 mm, 1200 mm (option)



Swing gear

Drive system	with fixed axial piston hydraulic motors, planetary gearbox, pinion
Swing ring	roller bearing with internal teeth
Brake	hydraulically released, spring-loaded multi-disc holding brake
Swing speed	0-1.8 rpm continuously variable
Speed control	both swing modes are possible - speed control or free swing for speed control: a multi-disc holding brake locks automatically at zero swing motion.



Hoisting gear

Winches 1/2 as crane winches	Internal low-maintenance planetary gearbox in oil bath, load support by the hydraulic system, spring-loaded, multi-disc holding brake, pressure controlled, variable flow hydraulic motors for the main winches, full utilisation of engine power as the winch speed is automatically adjusted to suit the respective line pull
Line pull in the 9 th layer	158.4 kN
Rope diameter	28 mm
Drum diameter	710 mm
Rope speed	0-130.7 m/min
Rope capacity in 9 layers	850 m
Option - winches 1/2 as free-fall winches	free fall: clutch and braking functions are provided by the service brake (low wear and maintenance-free multi-disc brake in compact design)







Boom/jib luffing winches

Main boom	Double winch
Line pull	max. 2 × 223 kN
Rope diameter	28 mm
Boom luffing	15-86° in 186 s
Jib	
Line pull	max. 138 kN
Rope diameter	20 mm
Boom luffing	15-78° in 108 s (2421.xx)

Operating weight

Composition of operating weight	Basic machine with crawler side frames (1500 mm) Cabin Winches 1 + 2 (incl. ropes 665 m + 540 m) A-frame 1 20 m main boom, consisting of boom foot (10 m), boom head (7 m) and boom section (3 m) 150.9 t rear counterweight 52.6 t carbody counterweight 300 t pulley block
Total weight	approx. 353.7 t

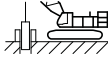
Operation modes

	 Lifting mode	 Grab mode	 Personnel lifting mode	 Foundation work
 Land	✓	✓	✓	✓
 Floating structure (barge operation)	✓	✓	✓ *	✓

* only valid for jack-up barges

Optional equipment

Basic machine

Additional hydraulics for free fall operation
 Carbody counterweight slab with assembly platform (2x)
 Load hooks/pulley blocks 16 / 50 / 100 / 160 / 220 / 300 / 430 t
 Painting in customer design
 Rotation-free hoist rope, 28 mm, 2160 N/mm², 240 / 400 / 540 / 665 m / 840 m with crane winch
 Track pads 1200 mm wide
 Track shifting hydraulic
 Winches 1/2 as free-fall winches, incl. hands-free quick connect

Economy and ecology

Aux. power unit (APU, 2.8 kW)
 Eco-Silent Package

Boom/jib

Luffing jib: luffing winch

Boom/jib other

Additional fall protection harness for 1 person
 Rope guide (2825.xx) ≥ 20 m
 Walkways for main boom sections 3 / 6 / 12 m
 Walkways for main boom sections 3 / 6 / 12 m, incl. fall protection

Application packages

Assembly radio remote control
 Cabin elevator 6 m hydraulic
 External supply incl. battery charger (100-240 V AC / 750 W)
 Leader application
 Main winch constant tension for one winch

Operation mode: foundation work

Operation mode: Personnel lifting mode

Radio remote control

Radio remote control (preparation)

Rope reeving function via radio remote control

Tagline winch 2 t free fall

Two hook operation

Use of luffing jib winch as auxiliary winch

Vibration damper for vibrator 120 / 160 / 250 / 500 / 800 kN

Winch synchronization

Special features

Crane Planner 2.0

LiDAT

Self-assembly system

Jack-up system telescopic

Reeving winch

Self-assembly cylinder

Self-assembly system counterweight

Service package

Central lubrication swing ring bearings / outside
 Cold package -25 °C / -40 °C
 Gear oil level warning
 Hydraulic oil bypass filter
 Liebherr hydraulic oil plus 37 (longlife & bio)
 Liebherr hydraulic oil plus arctic (longlife & bio)
 Liebherr hydraulic oil plus arctic (longlife)
 Refuelling pump AdBlue

Safety features

Access control
 Additional access ladder for boom assembly
 Air intake shut-off valve
 Aircraft warning light
 Assistance system: Boom Up-and-Down Assistant
 Assistance system: Gradient Travel Aid
 Assistance system: Ground Pressure Indication and Visualization
 Assistance system: Horizontal Load Path
 Assistance system: Vertical Line Finder
 Cabin protection roof, FOPS 2, foldable
 Earth spike
 Lifting height indication for both hoist winches
 Lightning rod
 Mechanical angle display
 Plug&Play diesel-hydraulic back-up unit 18.4 kW
 Rear and side view cameras
 Swing and boom radius limit device
 Swing warning light
 Vandalism cabin protection
 Winch camera
 Zoom camera at boom head

Operator's comfort

Additional access ladder
 Additional ignition key
 Additional floodlights
 Adjustable, additional LED lights, boom foot
 Cabin air conditioner
 Cabin tilting device hydraulic
 Cabin window protection film
 Jump-start socket (NATO type)

Dimensions

Basic machine with undercarriage

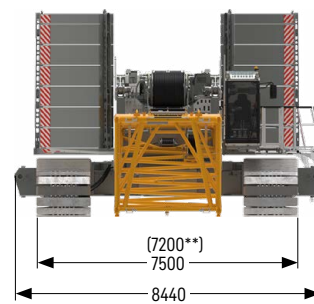
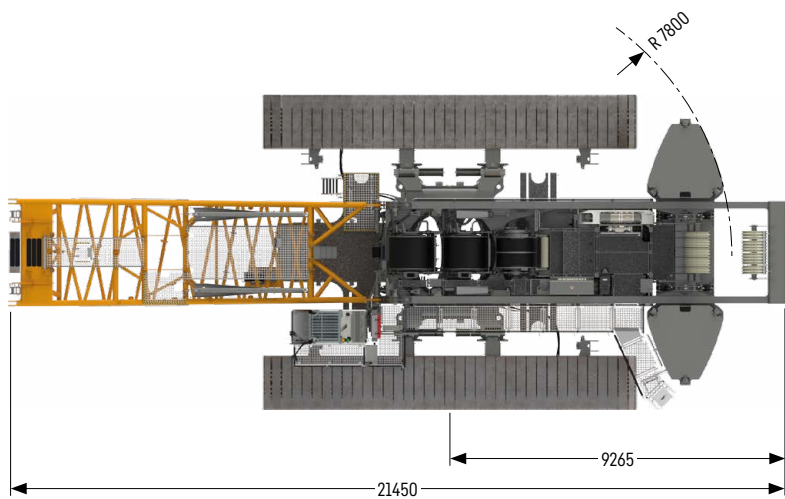
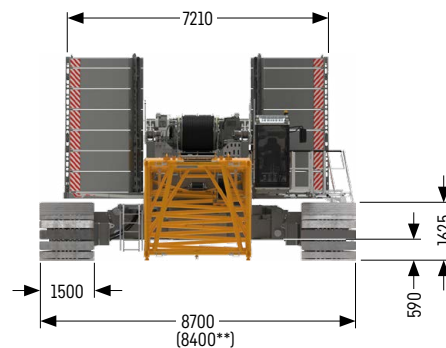
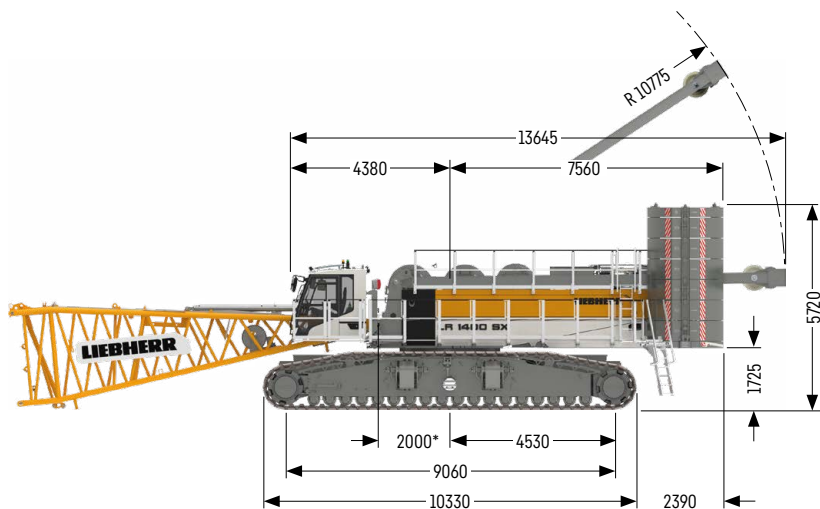

Track shifting hydraulic (option)

- * Boom pivot point
- ** Option: track pads, width 1200 mm

Transport dimensions and weights

Basic machine und main boom 2825.xx

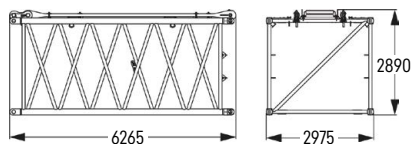
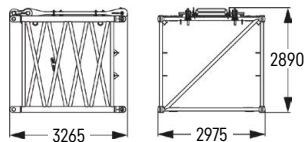
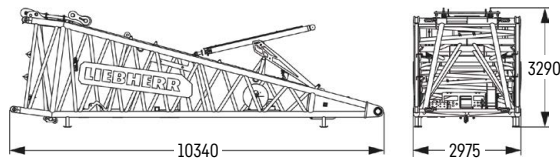
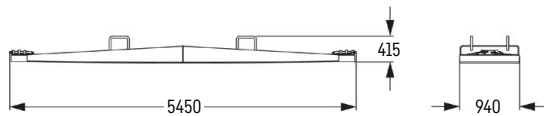
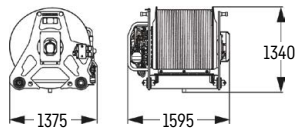
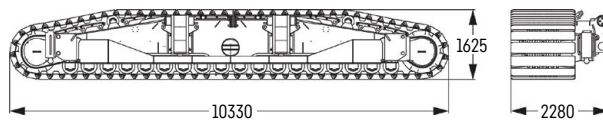
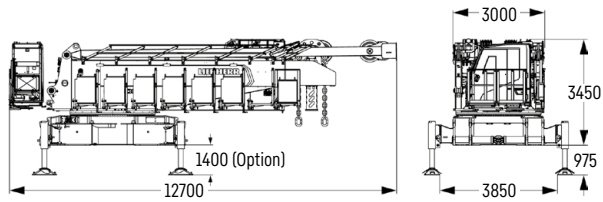

Basic machine

Weight	kg 46000
--------	----------

with A-frame 1, without winches 1 + 2, without boom foot, without rear counterweight, without carbody counterweight and crawler side frames, without self-assembly cylinder for counterweight

Crawler side frame

Weight flat track pads 1500 mm	kg 34841
Weight flat track pads 1200 mm (option)	kg 30911

Winch 1/2

Weight winch 1 and/or 2 as crane winch*	kg 2737
Weight winch 1 and/or 2 as free-fall winch*	kg 3230
Weight of hoist ropes	kg/m 4.2

* each in the heaviest version, without rope

Ground pressure reduction plate

Weight	kg 1511
--------	---------

Boom foot 10 m (No. 2825.32)

Weight including winch	kg 7913
Weight without winch	kg 6914

Boom section 3 m (No. 2825.32)

Weight including boom pendants	kg 1936
Weight including boom and jib pendants	kg 2084

Boom section 6 m (No. 2825.32)

Weight including boom pendants	kg 2913
Weight including boom and jib pendants	kg 3151

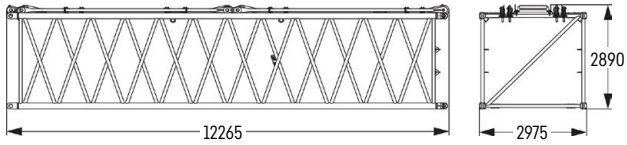

Boom section 12 m (No. 2825.32)

Weight including boom pendants	kg	5229
Weight including boom and jib pendants	kg	5704

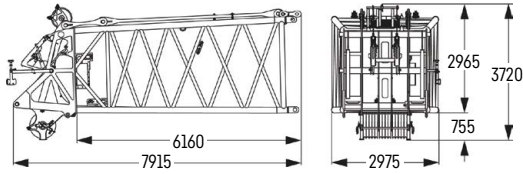

Boom head 7 m (No. 2825.32)

Weight including boom pendants	kg	7020
--------------------------------	----	------

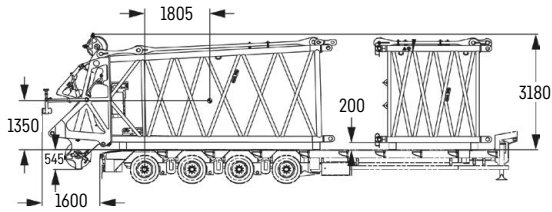

Transport option -

boom head 7 m (No. 2825.32) + boom section 3 m (No. 2825.32)

Boom head 7 m		
Weight including boom pendants	kg	7020
Boom section 3 m		
Weight including boom pendants	kg	1936
Weight including boom and jib pendants	kg	2084

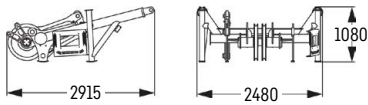

Auxiliary jib

Weight	kg	1270
--------	----	------

Transport option 2825.xx / 2421.xx

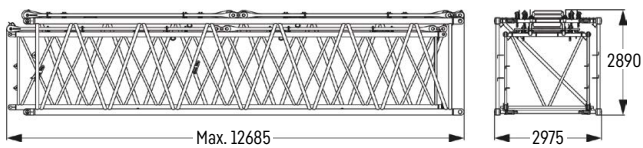

Transport option (No. 2825.xx / 2421.xx)

No. 2825.xx / 2421.xx	m	3 / 3	6 / 6	12 / 12
Weight including pendants	kg	2844	4275	8151

Fixed jib 1507.20

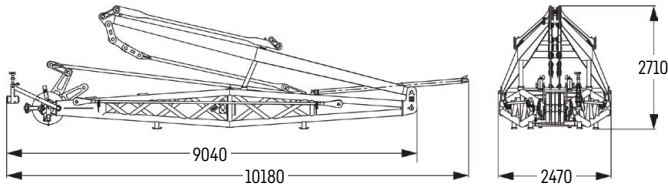

Fixed jib 8 m (No. 1507.20)

Weight including pendants	kg 3355
---------------------------	---------

Fixed jib 1713.xx



Jib head 7 m (No. 1713.21)

Weight including pendants	kg 1375
---------------------------	---------

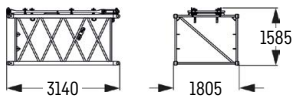

Jib section 3 m (No. 1713.18)

Weight including pendants	kg 420
---------------------------	--------

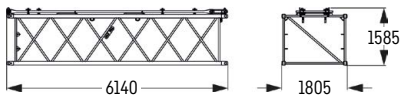

Jib section 6 m (No. 1713.18)

Weight including pendants	kg 630
---------------------------	--------

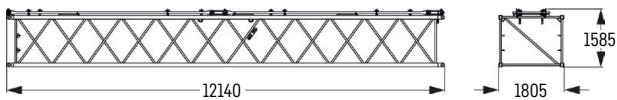

Jib section 12 m (No. 1713.18)

Weight including pendants	kg 1140
---------------------------	---------

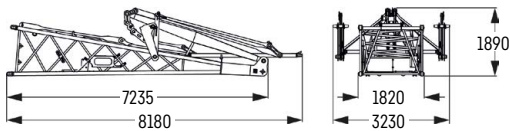

Jib foot 7 m with A-frame (No. 1713.22)

Weight including pendants	kg 2678
---------------------------	---------

Fixed jib 1916.xx

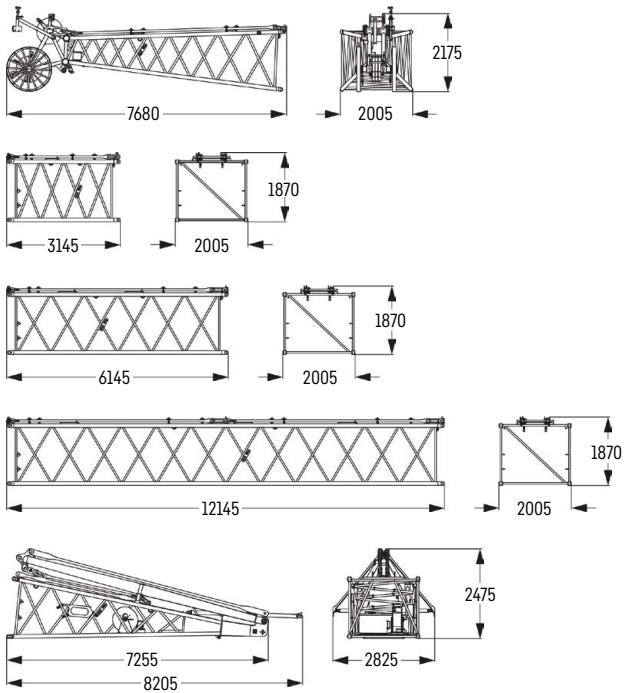

Jib head 7 m (No. 1916.21)

Weight including pendants	kg 1520
---------------------------	---------

Jib section 3 m (No. 1916.18)

Weight including pendants	kg 453
---------------------------	--------

Jib section 6 m (No. 1916.18)

Weight including pendants	kg 690
---------------------------	--------

Jib section 12 m (No. 1916.18)

Weight including pendants	kg 1247
---------------------------	---------

Jib foot 7 m with A-frame (No. 1916.22)

Weight including pendants	kg 2816
---------------------------	---------

Luffing jib 2316.xx

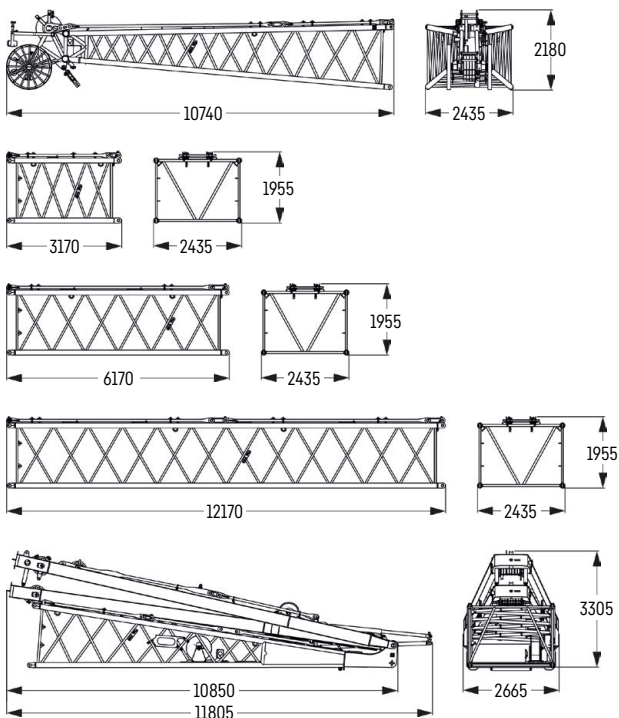

Jib head 10 m (No. 2316.20)

Weight including pendants	kg 2454
---------------------------	---------

Jib section 3 m (No. 2316.20)

Weight including pendants	kg 611
---------------------------	--------

Jib section 6 m (No. 2316.20)

Weight including pendants	kg 961
---------------------------	--------

Jib section 12 m (No. 2316.20)

Weight including pendants	kg 1800
---------------------------	---------

Jib foot 10 m with A-frames 2 + 3 (No. 2316.22)

Weight including pendants	kg 8208
---------------------------	---------

Luffing jib 2421.xx

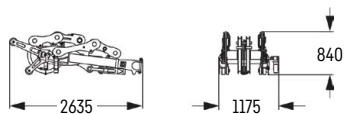
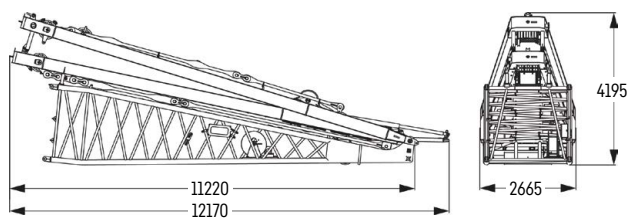
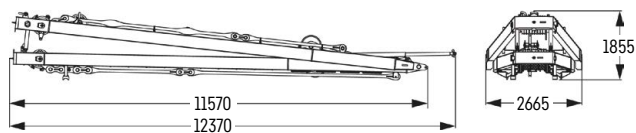
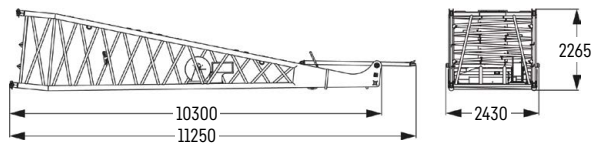
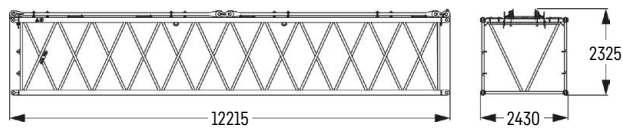
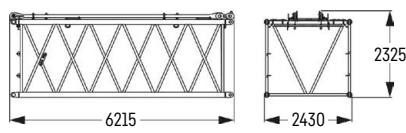
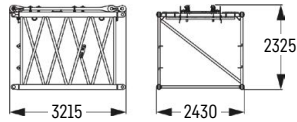
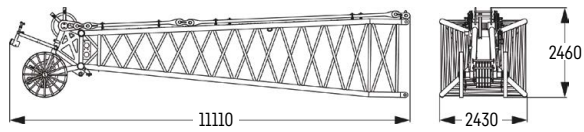

Jib head 10 m (No. 2421.25)

Weight including pendants	kg 3521
---------------------------	---------

Jib section 3 m (No. 2421.23)

Weight including pendants	kg 904
---------------------------	--------

Jib section 6 m (No. 2421.23)

Weight including pendants	kg 1357
---------------------------	---------

Jib section 12 m (No. 2421.23)

Weight including pendants	kg 2442
---------------------------	---------

Jib foot 10 m (No. 2421.32)

Weight including pendants	kg 3393
---------------------------	---------

A-frames 2 + 3

Weight	kg 5917
--------	---------

Transport option – jib foot 10 m with A-frames 2 + 3 (No. 2421.32)

Weight including pendants	kg 9310
---------------------------	---------

Auxiliary jib

Weight	kg 900
--------	--------

Counterweight

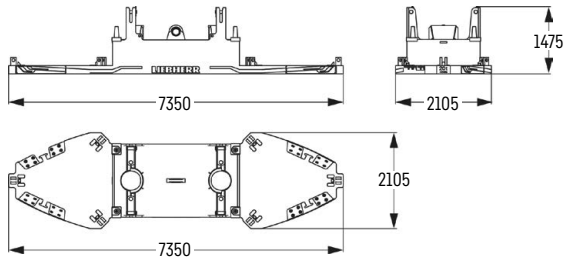

Basic counterweight slab without tie-down (1x)

Weight	kg 20109
--------	----------

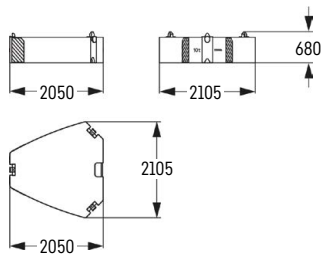

Counterweight slab (12x)

Weight	kg 10000
--------	----------

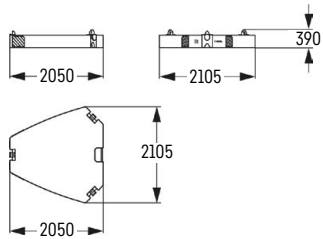

Counterweight slab (2x)

Weight	kg 5000
--------	---------

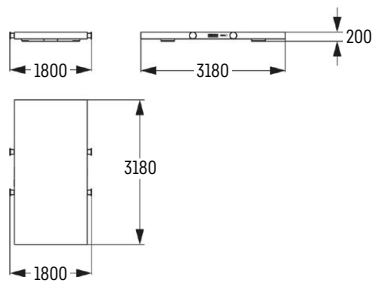

Carbody counterweight slab (2x)

Weight	kg 6200
--------	---------

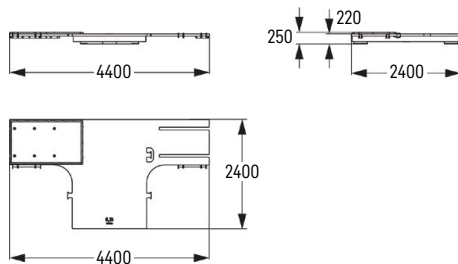

Carbody counterweight slab with assembly platform (2x) (option)

Weight	kg 6200
--------	---------

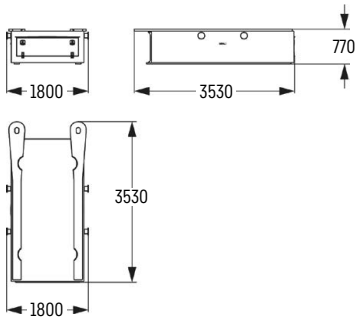

Carbody counterweight (2x)

Weight	kg	20100
--------	----	-------

Pulley block with additional weights / load hooks

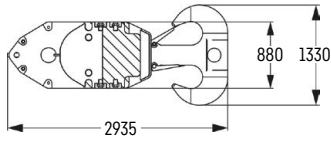

430 t pulley block - 13 pulleys

Width	mm	2350
Weight	kg	5500 / 6500 / 7500 / 8500 / 9500

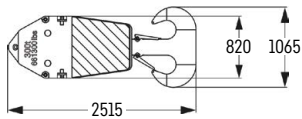

300 t pulley block - 11 pulleys

Breite	mm	1220
Weight	kg	3200 / 5500

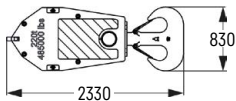

220 t pulley block - 7 pulleys

Width	mm	1305
Weight	kg	2000 / 3880 / 5760

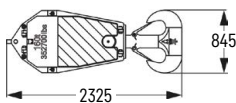

160 t pulley block - 5 pulleys

Width	mm	925
Weight	kg	1600 / 2800 / 4000

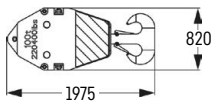

100 t pulley block - 3 pulleys

Width	mm	625
Weight	kg	1100 / 2050 / 3000

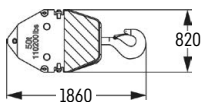

50 t pulley block - 1 pulley

Width	mm	540
Weight	kg	800 / 1600 / 2400

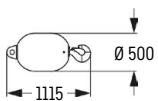

16 t load hook

Weight	kg	900
--------	----	-----

Self-assembly system

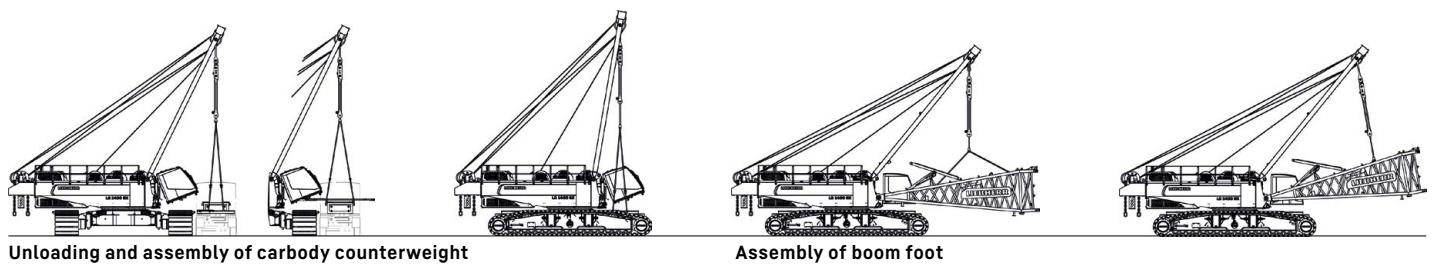
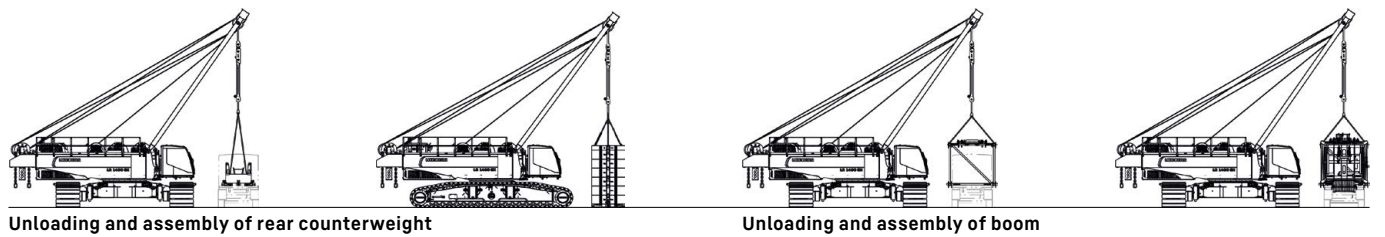
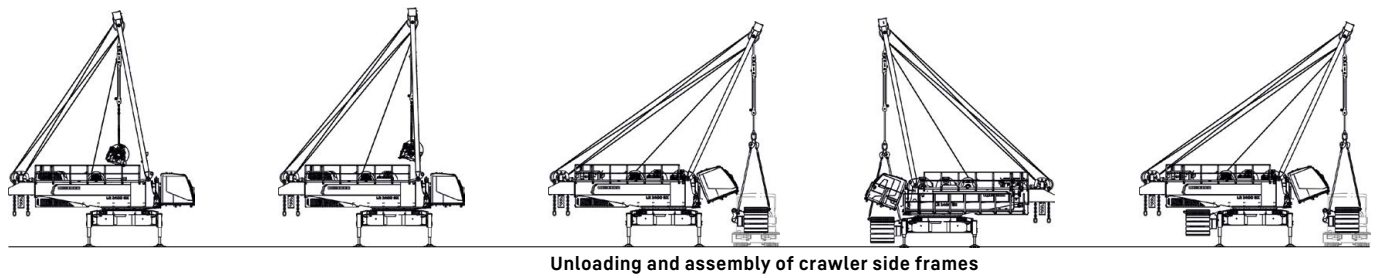
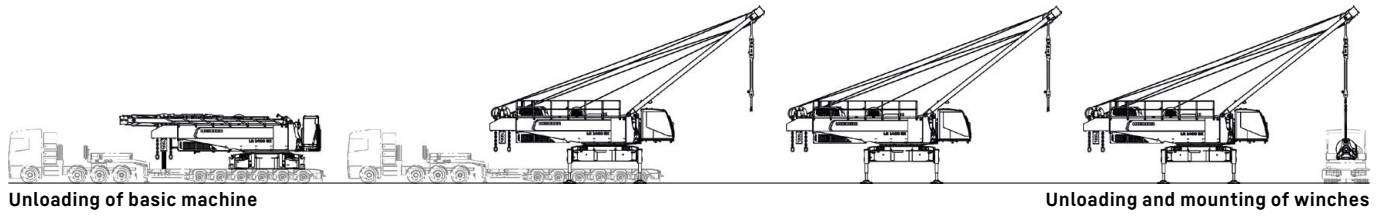

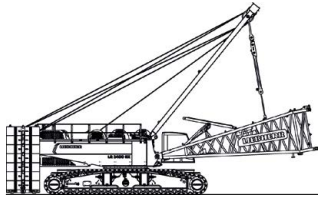

Assembly of rear counterweight

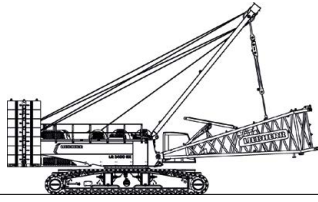

Assembly of main boom

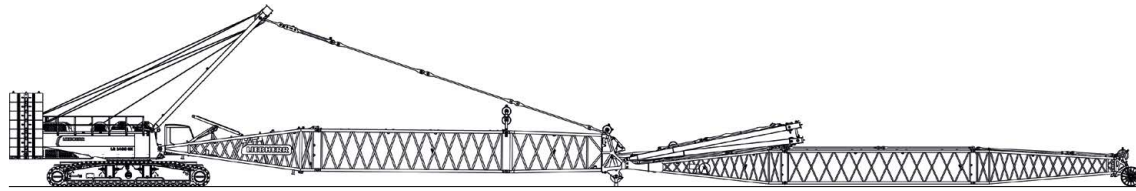
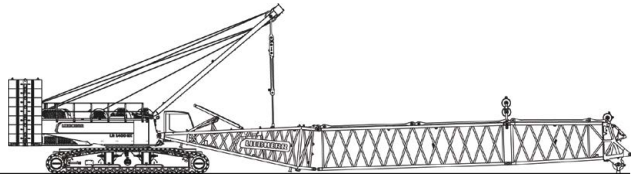

Assembly of luffing jib, reeving of hoist and luffing jib ropes



Erecting of main boom and luffing jib

Boom combinations

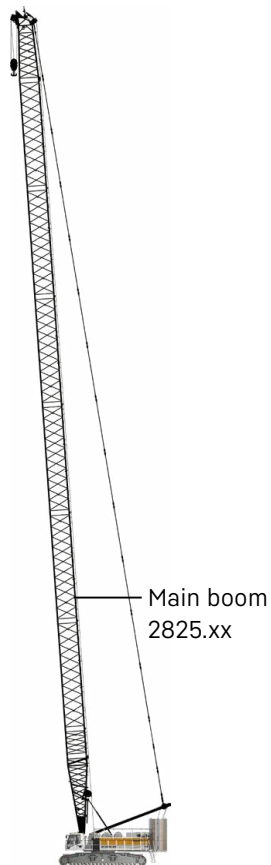

Main boom

Mode 1

Max. length

2825.xx m 95

Further information on page 22.

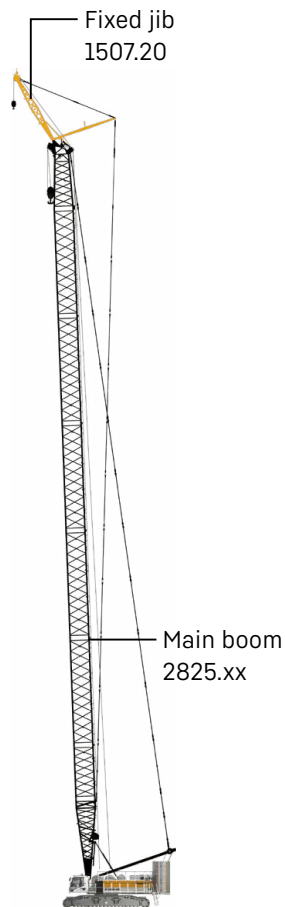

Main boom + fixed jib

Mode 3

Max. combination

2825.xx m 86

1507.20 m 8

Total length m 94

Further information on page 36.

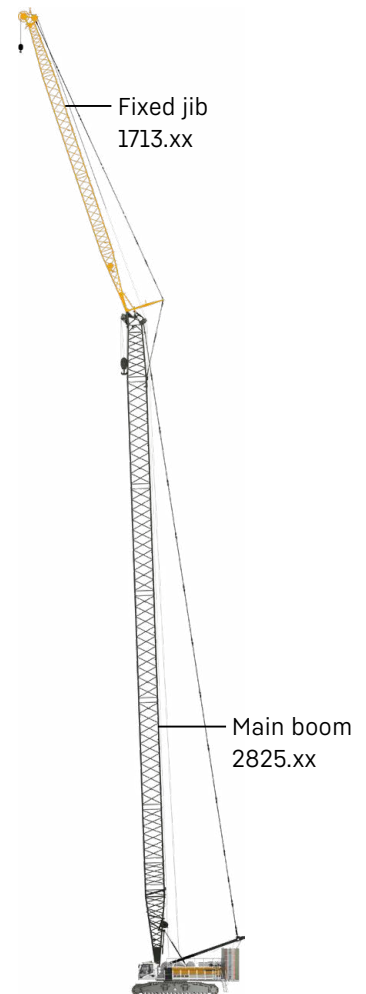

Main boom + fixed jib

Mode 3

Max. combination

	30°	15°
2825.xx	m 80	80
1713.xx	m 35	35
Total length	m 115	115

2825.xx m 80

1713.xx m 35

Total length m 115

Further information on page 40.

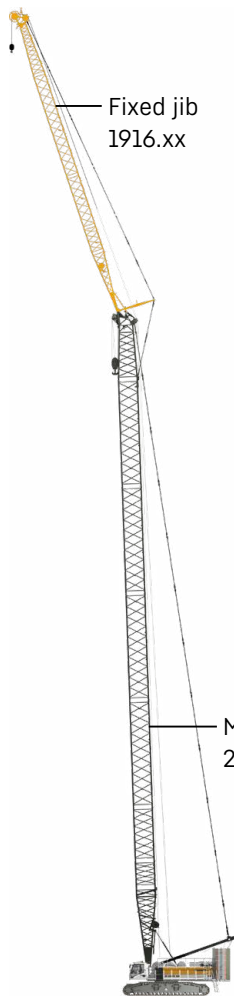

Main boom + fixed jib

Mode 3

Max. combination		30°	15°
2825.xx	m	77	77
1916.xx	m	50	50
Total length	m	127	127

Further information on page 38.

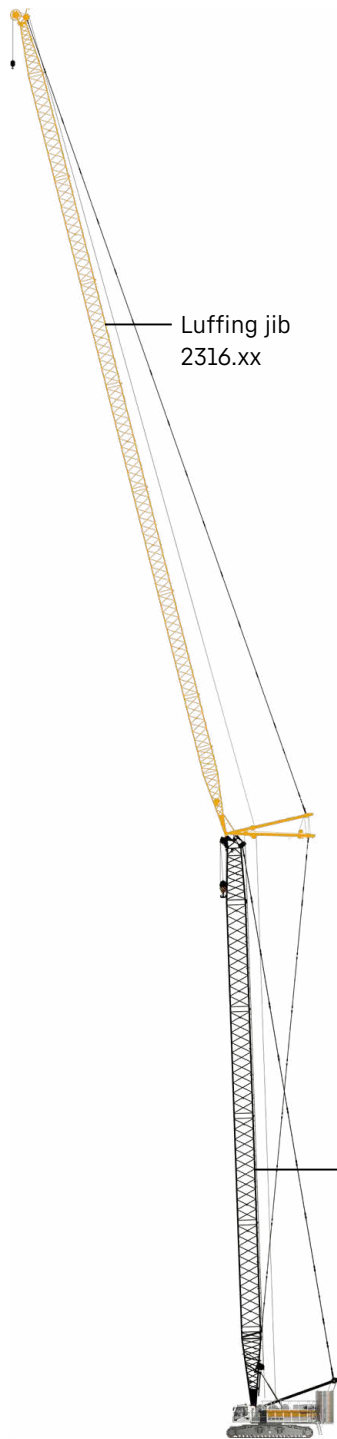

Main boom + luffing jib

Mode 4

Max. combination					
2825.xx	m	74	71	68	65
2316.xx	m	50	74	98	113
Total length	m	124	145	166	178

Further information on page 30.

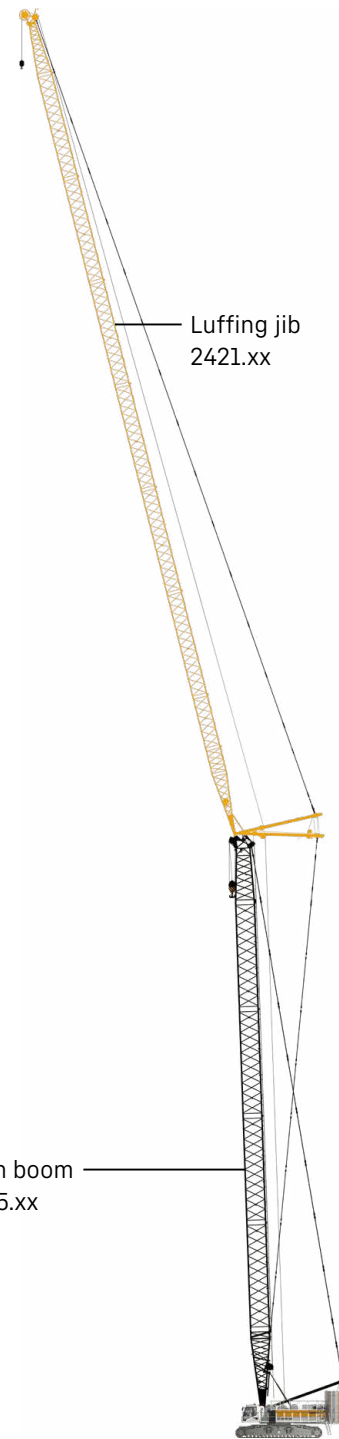

Main boom + luffing jib

Mode 4

Max. combination					
2825.xx	m	71	68	65	62
2421.xx	m	50	68	92	110
Total length	m	121	136	157	172

Further information on page 24.

Main boom 2825.xx

Boom lengths 20-95 m

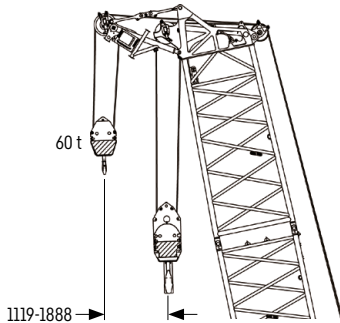

Auxiliary jib 60 t (option)

The maximum capacity of the auxiliary jib is 60 t. The corresponding load chart is programmed in the LML system.

Main boom configuration 2825.xx

Boom section	Amount of boom sections												
	1	2	3	4	5	6	7	8	9	10	11	12	13
Boom foot 10 m	1	1	1	1	1	1	1	1	1	1	1	1	1
Boom section 3 m	1		1		1		1		1		1		1
Boom section 6 m		1	1			1	1			1	1		
Boom section 12 m				1	1	1	1	2	2	2	2	3	3
Boom head 7 m	1	1	1	1	1	1	1	1	1	1	1	1	1
Boom length [m]	20	23	26	29	32	35	38	41	44	47	50	53	56
Auxiliary jib	✓	✓	✓	✓	✓	✓	✓	✓	✓	✓	✓	✓	✓
Boom foot 10 m	1	1	1	1	1	1	1	1	1	1	1	1	1
Boom section 3 m		1		1		1		1		1		1	
Boom section 6 m	1	1			1	1			1	1			1
Boom section 12 m	3	3	4	4	4	4	5	5	5	5	6	6	6
Boom head 7 m	1	1	1	1	1	1	1	1	1	1	1	1	1
Boom length [m]	59	62	65	68	71	74	77	80	83	86	89	92	95
Auxiliary jib	✓	✓	✓	✓	✓	✓	✓	✓	✓	✓			

Load capacities with main boom

Load capacities in [t]

	Boom length [m]											
	20	26	32	44	50	56	62	68	74	80	89	95
4.9	400.0*											
6	351.0	348.2	345.7									
7	304.9	301.1	299.9	289.7	265.9							
8	266.6	265.9	263.1	257.4	255.0	242.1	203.7					
9	239.7	236.9	235.5	231.6	226.9	222.1	200.8	179.8	158.2			
10	215.6	213.3	212.7	207.5	205.8	202.4	189.5	175.1	157.4	143.3	119.5	
11	195.8	195.7	192.7	189.0	186.2	184.6	177.3	169.5	152.4	141.2	119.5	106.0
14	153.0	153.1	152.0	148.2	146.8	143.4	137.8	132.6	127.5	122.7	113.5	102.2
17	122.0	122.1	122.0	121.1	119.5	115.9	111.7	107.7	103.8	100.1	94.7	91.2
20	97.5	97.8	97.7	96.7	96.1	95.5	93.1	89.9	86.7	83.6	79.1	76.2
22		85.9	85.9	84.9	84.2	83.6	83.0	80.6	77.7	74.9	70.8	68.2
24		76.4	76.4	75.4	74.7	74.1	73.4	72.7	70.1	67.6	63.8	61.3
26		68.5	68.6	67.6	66.9	66.3	65.6	64.9	63.6	61.2	57.8	55.5
28			62.0	61.1	60.4	59.8	59.0	58.3	57.6	55.8	52.5	50.3
30			56.4	55.6	54.9	54.2	53.5	52.8	52.0	51.0	47.9	45.8
32			51.6	50.8	50.1	49.5	48.7	48.0	47.2	46.5	43.8	41.8
34				46.7	46.0	45.3	44.6	43.8	43.0	42.3	40.2	38.3
36				43.0	42.3	41.7	40.9	40.2	39.4	38.7	36.9	35.1
38				39.8	39.1	38.5	37.7	37.0	36.2	35.4	34.0	32.2
40				36.9	36.3	35.6	34.8	34.1	33.3	32.6	31.3	29.6
42				34.3	33.7	33.1	32.3	31.6	30.8	30.0	28.8	27.2
44				31.9	31.4	30.8	30.0	29.3	28.4	27.7	26.5	25.0
46					29.2	28.6	27.9	27.2	26.3	25.6	24.4	23.0
48					27.3	26.7	26.0	25.2	24.4	23.6	22.3	21.1
50					25.4	25.0	24.2	23.5	22.7	21.8	20.4	19.4
52						23.3	22.6	21.9	21.0	20.1	18.7	17.7
54						21.8	21.1	20.4	19.4	18.6	17.1	16.1
56						20.4	19.7	19.0	18.0	17.1	15.8	14.8
58							18.4	17.6	16.6	15.8	14.4	13.4
60							17.1	16.3	15.5	14.6	13.2	12.2
62							15.9	15.2	14.3	13.4	12.0	11.0
64								14.1	13.2	12.3	10.9	9.9
66								13.0	12.1	11.2	9.9	8.8
68								12.0	11.1	10.3	8.9	7.9
70									10.2	9.4	8.0	7.0
72									9.3	8.5	7.1	6.1
74									8.4	7.6	6.3	5.3
76										6.8	5.5	4.5
78										6.1	4.8	3.8
80										5.4	4.1	3.1
82											3.4	
83											3.1	
84											2.8	
86											2.1	
86.4											2.0	

* with heavy lift configuration

Carbody counterweight: 52.6 t with 1500 mm flat track pads

Rear counterweight:

100.5 t	140.9 t
120.5 t	150.9 t



TLT 13630772 / 306561. Above load charts are for reference only. For actual lift duty please refer to load chart in operator's cabin or manual. Otherwise we recommend you to plan your lifting job using Crane Planner 2.0.

www.liebherr.com/CranePlanner

Crane Planner 2.0

Luffing jib 2421.xx

Jib lengths 20-110 m

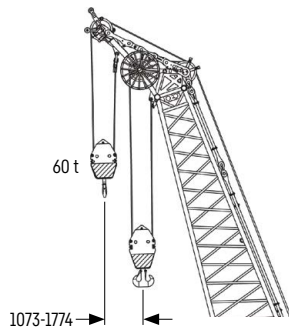

Auxiliary jib 60 t (option)

The maximum capacity of the auxiliary jib is 60 t.

Jib configuration 2421.xx

Jib section	Amount of jib sections															
	20	23	26	29	32	35	38	41	44	47	50	53	56	59	62	65
Jib foot 10 m	1	1	1	1	1	1	1	1	1	1	1	1	1	1	1	1
Jib section 3 m		1		1		1		1		1		1		1		1
Jib section 6 m			1	1			1	1		1	1	1		1	1	1
Jib section 12 m					1	1	1	1	2	2	2	2	3	3	3	3
Jib head 10 m	1	1	1	1	1	1	1	1	1	1	1	1	1	1	1	1
Jib length [m]	20	23	26	29	32	35	38	41	44	47	50	53	56	59	62	65
Auxiliary jib	✓	✓	✓	✓	✓	✓	✓	✓	✓	✓	✓	✓	✓	✓	✓	✓
Jib foot 10 m	1	1	1	1	1	1	1	1	1	1	1	1	1	1	1	1
Jib section 3 m		1		1		1		1		1		1		1		1
Jib section 6 m			1	1			1	1			1	1			1	1
Jib section 12 m	4	4	4	4	5	5	5	5	6	6	6	6	7	7	7	7
Jib head 10 m	1	1	1	1	1	1	1	1	1	1	1	1	1	1	1	1
Jib length [m]	68	71	74	77	80	83	86	89	92	95	98	101	104	107	110	
Auxiliary jib	✓	✓	✓	✓	✓	✓	✓	✓	✓	✓	✓	✓	✓	✓	✓	✓

For main boom configuration please refer to the table on page 22.

Load capacities with luffing jib

Load capacities in [t] with 20 m main boom [88/83/75/65°]

	Jib length 20 m				Jib length 38 m				Jib length 56 m			
	88°	83°	75°	65°	88°	83°	75°	65°	88°	83°	75°	65°
8.4	152.9											
12	146.3	152.9										
13	137.3	152.9			128.8							
16	107.7	125.6			101.4				82.1			
18	92.6	106.4	116.1		88.1	100.0			79.1			
23	53.2	57.4	85.0		64.9	71.4			61.1	65.8		
24		56.1	80.6	78.3	62.0	67.9			58.4	63.5		
27		65.2	67.7	63.9	53.4	57.8	66.5		50.0	54.9		
31			57.0	50.4	45.4	47.0	54.4		42.5	45.5		
34					40.0	38.4	47.8	50.0	37.8	40.4	45.7	
42					28.1	30.4	38.1	40.9	30.8	32.2	35.6	
44						28.8	35.6	38.5	28.8	29.9	33.1	
45							33.0	36.4	27.0	27.4	31.0	
48							31.6	35.2	26.1	26.2	30.4	33.7
54								32.2	23.8	23.0	27.4	30.7
56									19.0	19.0	23.0	25.2
57									17.3	18.2	21.8	23.7
58									16.5	17.9	21.2	23.1
60									15.3	17.5	20.7	22.5
62										16.0	19.5	21.4
65											18.4	20.3
65												18.6
	Jib length 74 m				Jib length 95 m				Jib length 101 m			
	88°	83°	75°	65°	88°	83°	75°	65°	88°	83°	75°	65°
20	48.5											
24	47.2				24.5							
28	42.6	45.3			23.7				20.1			
32	38.1	40.8			22.6				19.2			
34	35.0	38.0			22.1	23.0			18.7			
36	32.3	34.9			21.7	22.8			18.2	18.2		
40	28.6	30.2	31.8		20.7	21.3			17.6	17.7		
50	20.8	21.7	23.8		18.3	18.7	18.7		15.8	16.1		
55	17.9	18.6	20.3	22.2	15.0	16.4	17.3		14.0	15.3	15.0	
58	16.3	16.7	18.7	20.7	13.4	15.0	16.2		12.2	13.8	14.4	
61	14.9	15.0	17.1	18.8	11.9	13.7	15.2		10.7	12.5	14.0	
64	13.7	13.5	15.7	17.4	10.6	12.5	13.7		9.4	11.4	13.0	
67	12.5	12.4	14.5	16.0	9.5	11.4	12.5	13.2	8.2	10.5	11.7	
70	11.2	11.6	13.6	15.0	8.4	10.2	11.5	12.7	7.2	9.7	10.6	
73	9.8	10.8	12.6	13.9	7.3	9.1	10.4	11.5	6.2	8.5	9.7	10.8
76		9.9	11.6	12.9	6.4	8.0	9.4	10.5	5.2	7.4	8.8	9.8
79			10.5	11.8	5.6	7.1	8.4	9.6	4.2	6.3	7.8	8.8
80			10.2	11.5	5.3	6.8	8.1	9.3	4.0	6.0	7.4	8.6
83				10.4		6.0	7.2	8.4	3.1	5.0	6.5	7.8
87							6.2	7.4	2.1	3.9	5.4	6.7
92							4.9	6.2				5.6
99							3.0	4.2				3.8

Carbody counterweight: 52.6 t with 1500 mm flat track pads

Rear counterweight:

- 120.5 t
- 140.9 t
- 150.9 t



TLT 13630772 / 306561. Above load charts are for reference only. For actual lift duty please refer to load chart in operator's cabin or manual. Otherwise we recommend you to plan your lifting job using Crane Planner 2.0.

www.liebherr.com/CranePlanner

Crane Planner 2.0

Load capacities with luffing jib

Load capacities in [t] with 32 m main boom [88/83/75/65°]

	Jib length 20 m				Jib length 38 m				Jib length 56 m			
	88°	83°	75°	65°	88°	83°	75°	65°	88°	83°	75°	65°
9	152.9											
13	148.6				130.3							
17	112.3	125.4			106.8				77.8			
21	84.6	96.8	92.8		82.6	92.8			71.8			
23	68.8	86.4	82.8		74.6	84.9			67.0			
26		67.6	71.2		63.8	73.2			60.2	68.9		
29			62.2	59.0	56.4	63.0	60.9		52.0	59.8		
31				54.4	51.8	58.1	56.1		48.1	54.0		
36				45.3	42.4	47.4	46.8		39.1	44.1	45.3	
39					36.6	42.4	42.4	39.8	35.0	38.9	41.0	
41						38.9	39.8	37.4	32.8	36.1	38.5	
44							36.5	34.2	29.5	32.6	35.2	
48							32.7	30.7	25.8	28.4	31.5	
50								29.2	24.2	26.6	29.9	27.7
53								27.0	22.2	24.3	27.7	25.7
55									20.9	22.9	26.3	24.4
58									18.9	20.9	24.1	22.8
61										18.8	22.1	21.2
63											20.8	20.3
65											19.4	19.5
68												18.2
70												17.5
	Jib length 77 m				Jib length 95 m				Jib length 110 m			
	88°	83°	75°	65°	88°	83°	75°	65°	88°	83°	75°	65°
21	40.6											
25	39.6				23.0							
29	38.2				22.1				13.4			
31	37.6	38.0			21.8				13.0			
36	33.7	36.8			20.6	21.6			12.2			
41	30.2	32.5			19.7	20.8			11.4	11.5		
45	26.6	29.6	32.3		19.0	20.2			10.9	11.0		
52	21.4	23.3	26.6		17.5	19.2	17.7		9.9	10.2		
60	17.1	18.6	21.1		14.6	15.9	17.1		8.6	9.4	9.0	
62	16.2	17.6	20.0	18.9	14.0	15.2	17.0		8.1	9.0	8.9	
68	13.8	14.9	16.9	16.4	12.3	13.4	14.6		6.9	7.8	8.5	
72	12.1	13.3	15.2	15.0	11.0	12.0	13.4	13.4	6.2	7.1	8.0	
78	9.5	10.6	13.1	13.2	9.2	10.1	11.5	11.5			7.2	
81		9.2	12.1	12.4	8.5	9.3	10.5	10.6			6.4	6.5
83			11.4	11.8	8.0	8.8	10.0	10.1				6.5
87				10.8	6.9	7.8	8.9	9.2				5.7
91				9.9	5.8	6.7	8.1	8.3				5.0
94					4.9	5.9	7.4	7.6				4.6
98						4.8	6.6	6.9				3.7
103							5.6	6.0				2.6
106								5.5				2.1
108								5.2				

Carbody counterweight: 52.6 t with 1500 mm flat track pads

Rear counterweight:

- 120.5 t
- 140.9 t
- 150.9 t

TLT 13630772 / 306561. Above load charts are for reference only. For actual lift duty please refer to load chart in operator's cabin or manual. Otherwise we recommend you to plan your lifting job using Crane Planner 2.0.

Load capacities with luffing jib

Load capacities in [t] with 47 m main boom [88/83/75/65°]

Radius [m]	Jib length 20 m				Jib length 38 m				Jib length 56 m			
	88°	83°	75°	65°	88°	83°	75°	65°	88°	83°	75°	65°
10	152.9											
14	140.8				113.4							
16	123.5	120.4			106.4							
17	115.3	113.7			101.8				67.2			
21	88.3	92.9			84.1	85.0			65.6			
23	74.5	85.0			76.4	78.0			63.7			
25		76.6	71.3		69.0	72.0			62.3			
28		66.6	62.0		59.9	64.5			55.3	59.4		
32			52.7		50.7	55.6	51.2		47.4	52.0		
35				43.0	45.0	49.9	45.8		41.8	47.5		
38				38.9	40.1	45.1	41.4		37.2	43.6		
40				36.5	36.5	42.3	38.9		34.6	40.3	37.0	
43						38.7	35.6		31.4	36.0	34.0	
46							32.7	29.1	28.3	32.7	31.2	
49							30.2	26.9	25.7	29.5	28.8	
52							27.9	24.9	23.6	26.8	26.6	
56								22.6	20.9	23.8	24.1	21.0
59								21.1	16.0	21.8	22.5	19.6
62										19.8	21.0	18.2
69											18.1	15.7
73												14.4
77												13.2
Radius [m]	Jib length 74 m				Jib length 95 m				Jib length 110 m			
	88°	83°	75°	65°	88°	83°	75°	65°	88°	83°	75°	65°
21	40.2											
26	39.6				20.9							
29	38.9				20.3				11.6			
31	38.6	38.7			20.0				11.4			
35	35.8	38.4			19.2				10.8			
38	33.6	37.7			18.7	19.0			10.4			
47	26.3	30.2			17.3	17.9			9.2	9.6		
52	22.8	25.6	24.5		16.5	17.2			8.6	9.1		
56	20.5	22.9	22.3		15.4	16.7	16.0		8.2	8.6		
60	18.3	20.5	20.4		14.5	15.7	15.9		7.8	8.3		
63	16.8	18.8	19.0		13.9	15.0	15.8		7.2	8.0	7.6	
70	14.1	15.6	16.3	13.4	12.2	13.6	13.4		6.2	7.0	7.3	
75	12.4	13.9	14.6	11.9	10.6	11.9	11.9		5.6	6.5	7.0	
78		12.8	13.7	11.1	9.8	11.0	11.1	8.0		6.2	6.6	
85			11.8	9.4	8.0	9.0	9.4	6.6			5.8	
87			11.3	9.0	7.5	8.6	9.0	6.2			5.6	4.2
94				7.6	5.5	7.2	7.6	5.0			4.0	3.0
96					4.9	6.8	7.3	4.7			3.5	2.7
100						5.9	6.6	4.1			2.7	2.2
105							5.8	3.4				
109								3.0				
112								2.6				

Carbody counterweight: 52.6 t with 1500 mm flat track pads

Rear counterweight:

- 120.5 t
- 140.9 t
- 150.9 t

TLT 13630772 / 306561. Above load charts are for reference only. For actual lift duty please refer to load chart in operator's cabin or manual. Otherwise we recommend you to plan your lifting job using Crane Planner 2.0.

Load capacities with luffing jib

Load capacities in [t] with 62 m main boom [88/83/75/65°]

Radius [m]	Jib length 20 m				Jib length 38 m				Jib length 56 m			
	88°	83°	75°	65°	88°	83°	75°	65°	88°	83°	75°	65°
10	132.2											
14	114.6				86.2							
17	104.2	102.2			81.4							
19	97.9	92.4			77.5				53.3			
23	78.7	77.5			70.3	70.9			52.4			
25		71.7			66.4	65.6			51.4			
28		64.6			59.4	58.9			48.9	52.1		
30		59.8	52.4		56.0	55.1			47.0	50.6		
36			42.8		44.4	46.1	39.4		40.3	42.2		
38			40.0		41.2	43.7	37.3		37.6	39.9		
42				30.2	16.0	38.9	33.6		33.4	35.9		
44				28.5		36.7	32.0		31.2	34.2	28.5	
47				26.2		33.8	29.5		28.2	31.9	26.5	
49				16.0			28.0		26.4	30.4	25.2	
52							25.9	21.1	24.2	28.5	23.5	
56							23.5	19.3	21.8	25.5	21.5	
59								18.0	19.9	23.5	20.2	
62								16.8		21.6	19.0	14.1
65								15.7		16.0	17.9	13.2
73											15.2	11.1
77												10.2
83												9.0
Radius [m]	Jib length 74 m				Jib length 95 m				Jib length 110 m			
	88°	83°	75°	65°	88°	83°	75°	65°	88°	83°	75°	65°
22	33.8											
26	33.7				18.6							
30	33.5				18.1				10.1			
33	33.3	32.4			17.6				9.8			
39	30.6	32.4			16.7	16.9			8.9			
45	27.4	30.0			15.8	16.4			8.2	8.5		
51	23.8	26.0	20.8		15.0	15.7			7.4	8.0		
56	21.2	23.2	18.5		14.3	15.2			6.9	7.5		
60	19.0	21.3	16.8		13.8	14.8	13.4		6.5	7.1		
68	15.5	17.8	14.1		12.8	13.9	10.9		5.3	6.3	6.2	
70	14.8	16.9	13.5		12.2	13.7	10.3		5.1	6.0	6.2	
73	13.7	15.8	12.6	8.2	11.3	13.2	9.5		4.8	5.7	6.0	
76	12.6	14.7	11.8	7.6	10.4	12.2	8.8		4.5	5.4	5.9	
82		12.6	10.5	6.5	9.0	10.4	7.4			4.8	5.4	
85			9.8	6.0	8.4	9.6	6.8	2.8			4.8	
87			9.4	5.6	7.8	9.2	6.5	2.5			4.5	
91			8.7	5.0	6.7	8.4	5.8	2.0			3.8	
93				4.7	6.1	8.0	5.4				3.4	
95				4.5	5.6	7.6	5.1				3.1	
98				4.1		6.9	4.6				2.7	
100				3.8			4.4				2.4	
110							3.1					

Carbody counterweight: 52.6 t with 1500 mm flat track pads

Rear counterweight:

- 120.5 t
- 140.9 t
- 150.9 t

TLT 13630772 / 306561. Above load charts are for reference only. For actual lift duty please refer to load chart in operator's cabin or manual. Otherwise we recommend you to plan your lifting job using Crane Planner 2.0.

Load capacities with luffing jib

Load capacities in [t] with 71 m main boom [88/83/75/65°]

Radius [m]	Jib length 20 m				Jib length 32 m				Jib length 38 m			
	88°	83°	75°	65°	88°	83°	75°	65°	88°	83°	75°	65°
11	109.8											
13	102.7				84.8							
14	99.2				83.6				74.1			
16	93.8				80.0				72.6			
19	87.1	86.6			73.9				67.6			
22	80.4	75.8			68.8	71.4			62.9			
24	71.8	70.1			65.3	66.0			60.4	64.0		
27		62.9			61.1	59.2			56.1	57.4		
29		58.9			57.1	55.4			53.8	53.6		
32			44.8		52.7	50.4			49.9	48.8		
34			42.2		48.3	47.6			46.9	46.0		
36			39.8		43.7	45.0	37.1		44.2	43.5		
40			35.8			40.7	33.3		38.3	39.2	31.9	
45				24.5			30.9			34.9	28.8	
47				23.3			28.1			33.1	26.9	
49				22.2			26.9				25.7	
52				20.7			25.0	18.6			24.0	
55								17.4			22.6	
57								16.7			21.7	15.5
60								15.7				14.5
64								14.4				13.4
69												12.0
Radius [m]	Jib length 44 m				Jib length 47 m				Jib length 50 m			
	88°	83°	75°	65°	88°	83°	75°	65°	88°	83°	75°	65°
16	63.5											
17	63.3				58.4							
18	62.8				58.3				53.2			
24	55.4				52.8				50.6			
26	53.1	57.8			50.5	56.5			48.5			
29	50.0	52.1			47.9	51.2			45.8	50.5		
34	45.2	44.7			43.1	43.9			41.6	43.3		
37	41.3	41.1			40.6	40.3			39.4	39.8		
41	36.5	37.1	29.9		35.4	36.3			35.6	35.8		
44	33.4	34.5	27.7		32.2	33.8	27.0		32.4	33.3	26.5	
46	31.1	33.0	26.4		30.4	32.2	25.7		30.7	31.7	25.2	
51		29.5	23.6		25.5	28.9	22.8		26.2	28.4	22.4	
53		28.1	22.5			27.7	21.8		24.2	27.2	21.4	
59			19.9	13.9			19.2			24.0	18.8	
61			19.1	13.3			18.5	12.6			18.1	
63			18.4	12.7			17.8	12.0			17.4	11.6
66				11.9			16.9	11.2			16.4	10.8
69				11.2				10.5			15.5	10.1
72				10.5				9.8				9.5
75				9.9				9.2				8.8
81												7.8
87												

Carbody counterweight: 52.6 t with 1500 mm flat track pads

Rear counterweight:

- 120.5 t
- 140.9 t
- 150.9 t

TLT 13630772 / 306561. Above load charts are for reference only. For actual lift duty please refer to load chart in operator's cabin or manual. Otherwise we recommend you to plan your lifting job using Crane Planner 2.0.

Luffing jib 2316.xx

Jib lengths 20-113 m

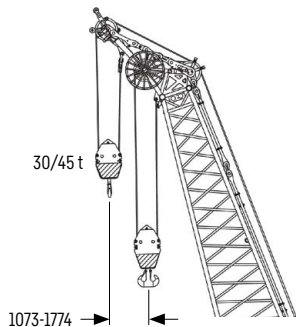

Auxiliary jib 30/45 t (option)

The maximum capacity of the auxiliary jib is 30/45 t.

Jib configuration 2316.xx

Jib section	Amount of jib sections															
	20	23	26	29	32	35	38	41	44	47	50	53	56	59	62	65
Jib foot 10 m	1	1	1	1	1	1	1	1	1	1	1	1	1	1	1	1
Jib section 3 m		1		1		1		1		1		1		1		1
Jib section 6 m			1	1			1	1		1		1		1		1
Jib section 12 m					1	1	1	1	2	2	2	2	3	3	3	3
Jib head 10 m	1	1	1	1	1	1	1	1	1	1	1	1	1	1	1	1
Jib length [m]	20	23	26	29	32	35	38	41	44	47	50	53	56	59	62	65
Auxiliary jib	✓	✓	✓	✓	✓	✓	✓	✓	✓	✓	✓	✓	✓	✓	✓	✓
Jib foot 10 m	1	1	1	1	1	1	1	1	1	1	1	1	1	1	1	1
Jib section 3 m		1		1		1		1		1		1		1		1
Jib section 6 m			1	1			1	1		1		1		1		1
Jib section 12 m	4	4	4	4	5	5	5	5	6	6	6	6	7	7	7	7
Jib head 10 m	1	1	1	1	1	1	1	1	1	1	1	1	1	1	1	1
Jib length [m]	68	71	74	77	80	83	86	89	92	95	98	101	104	107	110	113
Auxiliary jib	✓	✓	✓	✓	✓	✓	✓	✓	✓	✓	✓	✓	✓	✓	✓	✓

For main boom configuration please refer to the table on page 22.

Load capacities with luffing jib

Load capacities in [t] with 20 m main boom [88/83/75/65°]

	Jib length 20 m				Jib length 38 m				Jib length 56 m			
	88°	83°	75°	65°	88°	83°	75°	65°	88°	83°	75°	65°
8.3	117.0											
12	110.3	117.0										
13	103.7	117.0			74.2							
16	83.3	99.2			62.3				49.4			
18	70.3	84.8	111.6		56.6	62.4			47.4			
23	39.7	54.0	71.3		44.2	48.8			41.1	44.3		
25			59.8	74.6	39.6	44.3	50.8		38.5	41.2		
27			47.4	63.6	35.8	39.8	47.0		35.4	39.1		
31				47.1	29.6	33.0	38.8		31.0	32.9		
34					25.7	28.6	34.0	40.4	27.1	29.6	32.7	
40					19.4	21.8	25.9	30.4	21.6	24.0	26.4	
42						19.6	23.7	27.8	20.1	22.5	24.8	
44							21.4	25.6	18.7	20.8	23.1	
45							20.2	24.6	18.1	20.3	22.9	24.9
48								21.3	16.4	18.3	20.7	22.3
54									13.1	14.8	17.4	18.1
56									11.9	13.6	16.2	16.8
57									11.3	13.0	15.6	16.2
58									10.4	12.3	15.0	16.0
60										10.8	13.8	15.6
62											12.6	14.5
65												12.9
	Jib length 74 m				Jib length 95 m				Jib length 104 m			
	88°	83°	75°	65°	88°	83°	75°	65°	88°	83°	75°	65°
20	30.9											
24	28.9				17.6							
28	26.5	27.3			16.7				12.9			
32	24.3	25.8			15.5				12.0			
36	22.0	23.5			14.2	15.0			11.0			
40	20.0	21.0	22.3		13.1	13.8			10.3	10.7		
50	13.9	15.8	17.3		10.5	11.2	11.7		8.1	8.6		
55	11.9	13.0	15.7	16.5	8.6	9.8	10.6		7.2	7.7	8.2	
58	10.7	12.5	14.6	15.9	7.7	8.9	10.1		6.4	7.1	7.7	
61	9.7	11.3	13.2	14.8	7.0	8.2	9.3		5.6	6.4	7.2	
64	8.8	10.2	12.0	13.7	6.4	7.6	8.5		5.0	5.8	6.7	
67	7.9	9.2	10.9	11.9	5.7	6.9	7.9	8.4	4.4	5.3	6.0	
70	7.0	8.2	10.0	10.4	5.0	6.1	7.4	8.1	3.9	4.8	5.3	
73	6.1	7.2	8.9	9.1	4.3	5.4	6.6	7.5			4.8	5.7
76		6.1	7.8	8.2	3.7	4.7	5.9	7.0				5.4
80			6.4	7.0	3.0	3.9	5.0	5.9				4.2
83				6.1		3.4	4.4	5.1				3.6
85							4.1	4.6				3.2
87								4.2				2.8
89								3.8				2.5
90												2.3
91												2.1

Carbody counterweight: 52.6 t with 1500 mm flat track pads

Rear counterweight:

100.5 t	140.9 t
120.5 t	150.9 t



TLT 13630772 / 306561. Above load charts are for reference only. For actual lift duty please refer to load chart in operator's cabin or manual. Otherwise we recommend you to plan your lifting job using Crane Planner 2.0.

Load capacities with luffing jib

Load capacities in [t] with 32 m main boom [88/83/75/65°]

Radius [m]	Jib length 20 m				Jib length 38 m				Jib length 56 m			
	88°	83°	75°	65°	88°	83°	75°	65°	88°	83°	75°	65°
8.7	117.0											
9	117.0											
13	115.4				76.8							
17	88.8	116.5			62.5				48.1			
21	61.2	81.1	93.6		52.1	59.6			43.9			
23	47.9	67.6	83.7		48.2	54.5			41.0			
26		48.8	72.0		41.8	48.3			36.9	42.1		
29			59.4	60.0	37.1	42.4	51.4		32.4	36.4		
36				46.3	27.0	31.2	39.3		25.6	27.8	32.0	
39					23.6	27.5	34.2	41.1	23.5	25.2	29.1	
43						22.8	29.0	36.6	21.1	22.6	25.5	
48							22.8	29.8	18.6	19.8	22.1	
50								27.6	17.7	18.8	21.0	24.7
52								25.3	16.5	17.9	20.0	22.8
53								24.1	16.0	17.5	19.5	22.0
55									14.9	16.4	18.6	20.9
58									12.8	15.0	17.4	19.4
61										13.3	16.1	18.1
63											15.4	17.4
65											14.5	16.7
68												15.7
70												15.1
Radius [m]	Jib length 77 m				Jib length 107 m				Jib length 113 m			
	88°	83°	75°	65°	88°	83°	75°	65°	88°	83°	75°	65°
24	23.6											
27	22.4											
29	21.6				11.0				9.3			
36	19.4	20.1			9.4				8.3			
39	18.6	19.2			8.8	9.0			7.7			
41	18.2	18.6			8.5	9.0			7.4	7.6		
50	13.3	16.5	17.0		6.8	7.4			6.0	6.6		
57	9.6	14.0	15.6		5.6	6.2			5.1	5.4		
59	8.4	12.2	15.2		5.1	6.0	6.4			5.2		
61	7.3	10.4	14.9		4.6	5.4	6.2			5.0	5.3	
65	5.4	7.3	11.1	13.8	3.7	4.4	5.5				4.8	
70	3.8	4.4	6.9	9.5	2.7	3.4	4.7				3.9	
72	3.4	4.0	5.5	8.2	2.4	3.1	4.2				3.6	
74	3.0	3.6	4.5	7.0		2.8	3.8				3.1	
78	2.1	2.7	3.6	4.9			3.0				2.4	
79		2.4	3.4	4.5				3.3			2.2	
81		2.0	2.9	4.0				3.2				
82			2.7	3.7				3.0				
84			2.3	3.3				2.7				2.1
85			2.1	3.1				2.6				
89				2.3								
90				2.1								

Carbody counterweight: 52.6 t with 1500 mm flat track pads

Rear counterweight:

100.5 t	140.9 t
120.5 t	150.9 t

TLT 13630772 / 306561. Above load charts are for reference only. For actual lift duty please refer to load chart in operator's cabin or manual. Otherwise we recommend you to plan your lifting job using Crane Planner 2.0.

Load capacities with luffing jib

Load capacities in [t] with 47 m main boom [88/83/75/65°]

Radius [m]	Jib length 20 m				Jib length 44 m				Jib length 56 m			
	88°	83°	75°	65°	88°	83°	75°	65°	88°	83°	75°	65°
9.3	114.4											
15	110.2				57.8							
16	100.6	112.0			56.1							
18	86.9	108.8			52.6				43.3			
23	53.0	81.1			43.4	50.8			40.1			
25		67.9	72.2		40.4	47.3			38.9			
26		62.5	68.9		39.2	45.9			37.4	40.3		
28		49.2	63.0		36.2	42.3			34.0	39.5		
35				44.1	28.3	33.0	40.9		26.2	30.1		
40				37.6	23.7	27.9	35.1		22.6	25.6	31.0	
42				35.4	22.2	26.0	32.8		21.5	24.2	29.6	
43					21.4	25.1	31.9		20.9	23.6	28.4	
47					18.1	21.9	27.7		18.8	21.3	24.9	
49						20.2	40.6	25.8	17.9	20.2	23.3	
51						18.5	24.2	26.6	17.2	19.2	22.1	
54							21.8	24.8	16.0	17.8	20.5	
57							19.4	23.2	14.6	16.5	19.0	22.3
62								20.9		14.2	17.1	20.0
65								19.6			16.0	18.7
69											14.8	17.1
72												16.2
77												14.6
Radius [m]	Jib length 74 m				Jib length 95 m				Jib length 113 m			
	88°	83°	75°	65°	88°	83°	75°	65°	88°	83°	75°	65°
21	27.2											
25	26.6											
29	25.2				14.7				8.6			
31	24.6	25.3			14.4				8.5			
37	21.1	23.8			13.2				7.7			
43	18.3	20.2			12.0	12.8			6.8	7.1		
47	16.4	18.3	21.4		11.2	12.1			6.3	6.7		
50	15.4	16.8	20.6		10.8	11.5			5.8	6.4		
56	13.8	14.8	17.1		9.4	10.5			5.1	5.6		
58	13.2	14.2	16.2		8.9	10.0	10.7		4.9	5.4		
63	12.0	12.9	14.7		8.0	8.8	10.0			4.9		
64	11.8	12.6	14.4		7.8	8.6	9.9				5.0	
66	11.4	12.2	13.8		7.5	8.2	9.7				4.9	
72	9.5	10.8	12.2	14.3			8.3				4.2	
78		8.9	11.0	12.6			7.3				3.5	
80		8.3	10.5	12.1			6.9	8.0			3.2	
86			9.0	10.9			5.8	7.2			2.5	
89				10.4			5.3	6.8				2.5
94				9.6				5.8				2.2
99								5.0				
106								4.2				
113								3.4				

Carbody counterweight: 52.6 t with 1500 mm flat track pads

Rear counterweight:

100.5 t	140.9 t
120.5 t	150.9 t

TLT 13630772 / 306561. Above load charts are for reference only. For actual lift duty please refer to load chart in operator's cabin or manual. Otherwise we recommend you to plan your lifting job using Crane Planner 2.0.

Load capacities with luffing jib

Load capacities in [t] with 62 m main boom [88/83/75/65°]

Radius [m]	Jib length 20 m				Jib length 38 m				Jib length 56 m			
	88°	83°	75°	65°	88°	83°	75°	65°	88°	83°	75°	65°
9.8	93.7											
14	92.8				54.4							
17	89.2	91.9			54.4							
18	87.7	91.9			54.4				33.5			
23	57.3	78.7			47.9	53.6			33.3			
28		61.8	57.5		40.4	48.5			31.7	32.2		
30		48.7	53.9		38.2	45.8			31.4	32.2		
36			43.8		31.2	37.8	41.5		26.0	29.9		
38			41.1		28.9	35.3	39.3		24.3	28.9		
42				31.4	16.0	31.2	35.4		21.7	25.2		
44				29.7		28.7	33.5		20.6	23.7	29.7	
47				27.4		24.9	30.9		19.0	21.8	28.6	
50							28.7		17.7	20.2	25.6	
52							27.3	23.0	16.9	19.3	23.8	
55							25.5	21.4	15.9	18.0	21.8	
59								19.6	14.3	16.6	19.7	
62								18.4		15.8	18.4	16.8
64								17.6		15.1	17.6	16.2
66								16.9			16.9	15.6
69											16.0	14.7
73											15.0	13.6
83												11.2
Radius [m]	Jib length 74 m				Jib length 95 m				Jib length 113 m			
	88°	83°	75°	65°	88°	83°	75°	65°	88°	83°	75°	65°
22	21.1											
26	21.0				11.7							
30	20.9				11.6				6.2			
33	20.8	20.1			11.5				6.1			
39	19.9	20.1			11.4				5.7			
45	17.8	19.7			10.6	10.9			5.4	5.3		
51	15.3	17.5	18.4		9.8	10.6			4.9	5.1		
60	12.8	14.2	17.3		8.2	9.6			4.2	4.5		
68	11.0	12.1	14.3			8.1	9.0				4.0	
70	10.4	11.7	13.7			7.8	8.8				4.0	
73	9.6	11.1	12.9	11.4			8.4				3.9	
76	8.6	10.4	12.2	10.8			8.0				3.4	
80		9.4	11.3	10.0			7.5				3.0	
82		8.9	10.9	9.6			7.3				2.7	
85			10.3	9.0			6.7	6.6			2.2	
87			9.9	8.7			6.4	6.3				
90			9.2	8.2			5.8	5.8				
93				7.8			5.3	5.4				
96				7.4			4.9	5.0				
100				6.8				4.5				
102								4.3				
110								3.4				

Carbody counterweight: 52.6 t with 1500 mm flat track pads

Rear counterweight:

100.5 t	140.9 t
120.5 t	150.9 t

TLT 13630772 / 306561. Above load charts are for reference only. For actual lift duty please refer to load chart in operator's cabin or manual. Otherwise we recommend you to plan your lifting job using Crane Planner 2.0.

Load capacities with luffing jib

Load capacities in [t] with 71 m main boom [88/83/75/65°]

Radius [m]	Jib length 26 m				Jib length 38 m				Jib length 50 m			
	88°	83°	75°	65°	88°	83°	75°	65°	88°	83°	75°	65°
11.3	69.3											
14	68.7				48.6							
17	68.5				48.6							
20	65.8	67.4			48.4							
22	63.0	67.4			46.8							
24	57.8	67.4			45.6	47.6						
26	51.8	64.6			42.8	47.6			32.8			
30	39.1	56.6			37.9	45.4			30.8	33.1		
33		51.0	43.7		34.4	41.8			27.3	31.9		
36		41.4	40.1		31.3	38.5			24.4	30.2		
38		16.0	38.1		29.3	36.2	35.8		22.9	28.2		
42			34.5		23.9	32.1	32.4		20.5	24.3		
44			32.6			30.2	30.9		19.5	22.9	29.0	
46			30.9			27.6	29.6		18.6	21.6	27.7	
49				23.0			27.7		17.5	19.9	25.9	
52				21.6			25.9		16.6	18.5	23.7	
56				19.6			23.6	18.2		17.1	21.1	
60								16.8		16.0	19.0	
65								15.3			17.0	13.7
70								13.9			15.6	12.5
75												11.4
80												10.5
Radius [m]	Jib length 56 m				Jib length 65 m				Jib length 74 m			
	88°	83°	75°	65°	88°	83°	75°	65°	88°	83°	75°	65°
18	29.6											
25	29.5				22.8				18.6			
30	29.1	28.5			22.8				18.6			
35	26.9	28.4			22.8	21.9			18.6	17.8		
40	22.8	27.8			21.6	21.9			18.6	17.8		
46	19.4	22.6	26.3		19.5	21.2			16.8	17.8		
50	17.5	20.4	24.5		18.1	19.9	20.2		15.4	17.2		
55	16.0	18.1	22.0		16.3	18.5	20.1		14.2	15.5		
60	14.1	16.4	2		15.0	16.6	18.7		12.8	14.4		
64		15.5	18.2		13.2	15.5	17.3		11.9	13.3		
66		14.9	17.4	12.7	12.3	14.9	16.6		11.5	12.8		
68			16.7	12.2	11.4	14.2	16.0		11.1	12.3		
70			16.2	11.8		13.5	15.5		10.6	11.9		
74			15.3	10.9		12.0	14.4	9.7	9.4	11.1		
77				10.3			13.7	9.1	8.6	10.4	12.4	
80				9.8			13.1	8.6		9.7	11.8	
85				9.0			12.2	7.8			10.9	6.8
87				8.6				7.5			10.5	6.5
90								7.0			10.0	6.1
95								6.4				5.5
100												4.9
105												4.4

Carbody counterweight: 52.6 t with 1500 mm flat track pads

Rear counterweight:

100.5 t	140.9 t
120.5 t	150.9 t

TLT 13630772 / 306561. Above load charts are for reference only. For actual lift duty please refer to load chart in operator's cabin or manual. Otherwise we recommend you to plan your lifting job using Crane Planner 2.0.

Fixed jib 1507.20

Jib length 8 m

The jib length is 8 m, for main boom configuration please refer to the table on page 22.

Load capacities with fixed jib

Load capacities in [t] with 56 m main boom

Radius [m]	Jib length 8 m
8.8	117.0
10	116.8
14	113.3
20	95.0
26	67.4
32	50.2
38	38.9
44	31.0
50	25.1
54	21.9
57	19.8
59	18.5

Load capacities in [t] with 65 m main boom

Radius [m]	Jib length 8 m
9.1	116.5
12	116.2
18	101.6
26	66.5
34	44.9
40	34.9
46	27.8
52	22.4
56	19.5
60	16.8
64	14.4
67	12.8

Load capacities in [t] with 74 m main boom

Radius [m]	Jib length 8 m
10	102.3
14	101.0
18	87.8
24	69.5
32	48.1
40	33.8
46	26.6
52	21.2
58	16.6
64	13.0
70	9.9
75	7.7

Load capacities in [t] with 83 m main boom

Radius [m]	Jib length 8 m
9.8	93.5
12	93.4
18	88.1
24	65.9
32	45.4
42	30.1
52	19.9
62	12.8
68	9.5
74	6.8
78	5.2
82	3.8

Load capacities in [t] with 86 m main boom

Radius [m]	Jib length 8 m
10	89.1
12	89.1
18	85.4
26	58.6
34	40.7
42	29.3
52	19.4
62	12.3
72	7.1
78	4.7
82	3.2
85	2.2

Carbody counterweight: 52.6 t with 1500 mm flat track pads

Rear counterweight:

140.9 t

150.9 t



TLT 13630772 / 306561. Above load charts are for reference only. For actual lift duty please refer to load chart in operator's cabin or manual. Otherwise we recommend you to plan your lifting job using Crane Planner 2.0.

www.liebherr.com/CranePlanner

 **Crane Planner 2.0**

Fixed jib 1916.xx

Jib lengths 14-50 m

Jib configuration 1916.xx

Jib section	Amount of jib sections													
	1	1	1	1	1	1	1	1	1	1	1	1	1	1
Jib foot 7 m	1													
Jib section 3 m		1												
Jib section 6 m				1	1									
Jib section 12 m						1	1	1	1	2	2	2	2	3
Jib head 7 m	1	1	1	1	1	1	1	1	1	1	1	1	1	1
Jib length [m]	14	17	20	23	26	29	32	35	38	41	44	47	50	

For main boom configuration please refer to the table on page 22.

Load capacities with fixed jib

Load capacities in [t] with 20 m main boom

Radius [m]	Jib length 14 m		Jib length 20 m		Jib length 29 m		Jib length 41 m		Jib length 50 m	
	15°	30°	15°	30°	15°	30°	15°	30°	15°	30°
	11	75.9	74.0							
13	75.6	67.6	59.9							
14	75.3	64.5	58.8							
16	74.2	59.7	54.7	46.0	38.1					
20	68.2	51.6	48.9	39.9	33.7					
22	64.8	48.3	46.9	37.6	31.9	28.6	22.1			
27	55.1	42.7	41.6	33.0	28.1	25.2	19.2		19.0	
29	52.3	40.9	39.7	31.6	27.0	24.0	18.2	16.4	18.1	
35			34.6	28.4	23.9	21.1	15.8	14.3	16.0	14.3
40			31.5	27.1	22.0	19.4	14.2	13.0	14.3	12.8
49					19.8	17.7	12.0	11.3	11.9	10.8
54							11.1	10.6	11.0	10.0
61							10.2	10.3	10.0	9.0
69									8.8	8.5

Load capacities in [t] with 35 m main boom

Radius [m]	Jib length 14 m		Jib length 20 m		Jib length 29 m		Jib length 41 m		Jib length 50 m	
	15°	30°	15°	30°	15°	30°	15°	30°	15°	30°
	9	76.0								
12	75.6	73.5	60.7							
16	75.6	64.8	56.9	47.4	38.6					
17	75.6	63.0	55.5	46.3	37.6					
23	75.2	54.1	49.2	39.8	32.8	28.6	21.8			
27	66.8	49.7	46.2	36.7	30.4	26.5	20.0		18.9	
30	58.0	47.2	43.9	34.9	28.7	25.0	18.7	16.3	18.0	
36	45.4	42.8	40.2	31.5	26.0	22.6	16.7	14.7	16.3	14.3
43	35.4	35.5	35.6	28.8	23.6	20.5	14.8	13.3	14.5	12.6
47	16.0	31.1	32.0	27.8	22.4	19.6	13.9	12.6	13.6	11.9
53			26.7	26.7	20.9	18.4	12.7	11.5	12.2	10.7
62					20.0	17.6	11.0	10.0	10.4	9.1
74							9.1	9.0	8.3	7.6
82									7.2	7.0

Carbody counterweight: 52.6 t with 1500 mm flat track pads

Rear counterweight:

120.5 t 140.9 t 150.9 t

TLT 13630772 / 306561. Above load charts are for reference only. For actual lift duty please refer to load chart in operator's cabin or manual. Otherwise we recommend you to plan your lifting job using Crane Planner 2.0.

Load capacities with fixed jib

Load capacities in [t] with 50 m main boom

	Jib length 14 m		Jib length 20 m		Jib length 29 m		Jib length 41 m		Jib length 50 m	
	15°	30°	15°	30°	15°	30°	15°	30°	15°	30°
9	75.5									
12	75.4	73.8								
13	75.4	71.9	59.0							
16	75.4	66.7	56.8	48.0						
17	75.4	65.4	56.0	46.8	37.5					
23	72.8	58.0	51.2	41.6	33.8	28.7	21.8			
28	62.0	52.7	47.7	38.5	31.0	26.9	19.9		17.5	
30	56.4	51.3	46.5	37.1	30.3	26.0	19.3	16.4	16.8	
36	43.6	44.2	43.3	34.2	27.7	24.0	17.6	14.6	14.9	12.2
60	16.0	19.4	20.3	20.5	21.4	18.7	10.9	9.2	9.8	8.5
66			17.0	17.0	18.1	18.1	9.7	8.4	9.0	7.8
75					14.1	14.1	8.3	7.4	8.0	7.1
87							6.9	6.8	6.8	6.1
95									6.0	5.9

Load capacities in [t] with 65 m main boom

	Jib length 14 m		Jib length 20 m		Jib length 29 m		Jib length 41 m		Jib length 50 m	
	15°	30°	15°	30°	15°	30°	15°	30°	15°	30°
10	75.5									
13	75.4	72.7	57.2							
18	75.1	65.6	53.7	46.4	36.7					
24	72.4	59.1	50.0	42.4	33.7	28.4	21.5			
28	60.3	55.8	48.3	39.7	31.9	27.2	20.2		16.9	
31	52.2	53.2	46.6	38.4	30.7	26.4	19.4	15.4	16.0	
37	40.2	41.0	41.5	35.6	28.6	24.4	17.5	14.1	14.4	11.3
50	24.7	25.2	25.8	26.5	25.0	21.5	14.1	11.2	11.5	9.4
67	13.7	13.9	14.7	15.1	16.0	16.5	10.4	8.5	9.0	7.7
72	11.3	11.4	12.3	12.6	13.6	14.1	9.6	7.9	8.4	7.3
79			9.4	9.5	10.7	11.0	8.5	7.3	7.8	6.8
89							7.4	6.6	6.9	6.2
100							5.5	5.5	6.2	5.8
108									4.5	4.5

Load capacities in [t] with 80 m main boom

	Jib length 14 m		Jib length 20 m		Jib length 29 m		Jib length 35 m		Jib length 41 m	
	15°	30°	15°	30°	15°	30°	15°	30°	15°	30°
10	71.1									
14	70.0	66.0	51.8							
18	68.5	64.8	51.0	45.2	34.2					
24	65.0	60.5	48.5	42.6	32.3	27.2	25.6			
31	48.2	49.7	46.1	39.1	30.0	24.9	22.9	18.1		12.9
33	44.4	45.8	44.9	38.3	29.4	24.4	22.2	17.6		12.6
40	33.6	34.6	34.8	35.5	27.2	22.5	20.1	16.1		11.5
50	22.7	23.4	23.9	24.8	24.1	20.3	17.3	14.4		10.2
68	10.8	11.3	11.9	12.5	13.4	14.2	14.0	12.1		8.3
85	4.2	4.3	5.1	5.3	6.4	6.8	7.2	7.8		6.9
91			3.3	3.3	4.5	4.8	5.3	5.7		6.5
101							2.5	2.7		3.7
107										2.1
110										

Carbody counterweight: 52.6 t with 1500 mm flat track pads

Rear counterweight:

120.5 t 140.9 t 150.9 t

TLT 13630772 / 306561. Above load charts are for reference only. For actual lift duty please refer to load chart in operator's cabin or manual. Otherwise we recommend you to plan your lifting job using Crane Planner 2.0.

Fixed jib 1713.xx

Jib lengths 14-35 m

Jib configuration 1713.xx

Jib section	Amount of jib sections							
	1	1	1	1	1	1	1	1
Jib foot 7 m	1							
Jib section 3 m		1						
Jib section 6 m			1					
Jib section 12 m					1		1	
Jib head 7 m	1	1	1	1	1	1	1	1
Jib length [m]	14	17	20	23	26	29	32	35

For main boom configuration please refer to the table on page 22.

Load capacities with fixed jib

Load capacities in [t] with 20 m main boom

Radius [m]	Jib length 14 m		Jib length 20 m		Jib length 26 m		Jib length 29 m		Jib length 35 m	
	15°	30°	15°	30°	15°	30°	15°	30°	15°	30°
	7.7	60.0								
10	60.0		42.0							
13	52.2	39.4	35.8		26.0					
16	44.7	34.8	31.1	25.7	22.6		20.1		16.3	
24	31.8	27.3	23.3	20.0	16.4	13.9	14.6	12.4	11.6	9.6
32	25.2	23.5	18.4	16.6	12.9	11.1	11.4	10.1	8.8	7.6
38			16.0	15.1	10.8	9.7	9.8	8.8	7.4	6.5
41					10.0	9.2	9.1	8.4	6.8	6.0
44					9.4	8.9	8.6	8.0	6.3	5.7
48							8.0	7.9	5.8	5.3
50									5.6	5.2
52									5.3	5.1
54									5.1	5.1
55										5.1

Load capacities in [t] with 35 m main boom

Radius [m]	Jib length 14 m		Jib length 20 m		Jib length 26 m		Jib length 29 m		Jib length 35 m	
	15°	30°	15°	30°	15°	30°	15°	30°	15°	30°
	8.2	60.0								
11	60.0		40.9							
13	58.9	41.3	37.9		26.8					
15	53.6	38.7	35.4		24.8		21.8			
16	51.6	37.7	34.2	26.3	23.8		21.2			
19	46.6	34.5	31.0	24.5	21.5	16.6	19.1		15.0	
24	39.3	31.2	27.0	22.0	18.5	14.8	16.3	12.9	12.6	9.8
26	36.8	30.0	25.8	20.9	17.4	14.1	15.4	12.4	11.9	9.3
30	33.1	27.7	23.2	19.4	15.9	13.0	13.8	11.4	10.6	8.5
40	27.1	24.1	18.8	16.6	12.7	10.7	11.1	9.6	8.2	6.9
50			16.0	15.1	10.4	9.3	9.3	8.4	6.7	5.8
58					9.1	8.8	8.3	7.9	5.8	5.3
62							7.5	7.9	5.5	5.1
64									5.3	5.0

Carbody counterweight: 52.6 t with 1500 mm flat track pads

Rear counterweight:

120.5 t 140.9 t 150.9 t

TLT 13630772 / 306561. Above load charts are for reference only. For actual lift duty please refer to load chart in operator's cabin or manual. Otherwise we recommend you to plan your lifting job using Crane Planner 2.0.

Load capacities with fixed jib

Load capacities in [t] with 50 m main boom

	Jib length 14 m		Jib length 20 m		Jib length 26 m		Jib length 29 m		Jib length 35 m	
	15°	30°	15°	30°	15°	30°	15°	30°	15°	30°
8.8	60.0									
11	60.0		40.6							
14	59.3	41.1	37.8		26.1					
17	54.2	38.2	34.8	26.1	23.9		21.0		16.4	
20	49.3	35.7	32.1	24.7	22.1	16.5	19.2		15.0	
25	43.4	32.4	28.8	22.5	19.4	15.0	16.9	13.0	13.1	9.6
35	34.3	28.2	23.6	19.4	15.8	12.7	13.6	11.1	10.1	7.3
44	29.8	25.4	20.3	17.3	13.4	11.1	11.6	9.6	8.0	5.9
52	25.0	23.8	18.0	16.0	11.8	10.1	10.2	8.4	6.6	5.0
59	20.2	20.3	16.6	15.3	10.6	9.4	8.9	7.5	5.6	4.4
65			15.6	15.0	9.8	9.0	8.0	6.9	4.8	4.0
69					9.3	8.8	7.5	6.7	4.5	3.7
72					8.5	8.7	7.1	6.6	4.2	3.6
75							6.8	6.4	4.0	3.5

Load capacities in [t] with 65 m main boom

	Jib length 14 m		Jib length 20 m		Jib length 26 m		Jib length 29 m		Jib length 35 m	
	15°	30°	15°	30°	15°	30°	15°	30°	15°	30°
10	59.1									
13	57.8	42.4	39.2							
17	56.2	39.3	35.8	26.4	24.6		21.3			
20	51.6	37.3	33.8	25.2	22.8	16.6	19.9		15.3	
25	47.5	34.1	30.4	23.4	20.5	15.4	17.9	13.4	13.6	9.0
35	38.4	30.2	25.7	20.4	17.0	13.4	14.7	11.2	10.9	7.2
45	29.7	27.0	22.0	18.2	14.5	11.7	12.4	9.3	8.4	5.8
55	21.0	21.5	19.4	16.7	12.7	10.2	10.3	7.9	6.7	4.8
63	16.0	16.4	17.0	15.5	11.2	9.4	9.0	7.1	5.7	4.2
72	11.6	11.7	12.5	12.8	9.9	8.4	7.7	6.4	4.7	3.6
78			10.0	10.2	9.1	8.1	7.0	6.0	4.2	3.3
84					8.4	7.8	6.4	5.8	3.8	3.2
85					8.3	7.7	6.3	5.8	3.7	3.1
88							6.0	5.7	3.5	3.1

Load capacities in [t] with 80 m main boom

	Jib length 14 m		Jib length 20 m		Jib length 26 m		Jib length 29 m		Jib length 35 m	
	15°	30°	15°	30°	15°	30°	15°	30°	15°	30°
9.8	52.2									
12	51.9									
15	51.0	40.9	37.1		25.3					
19	49.8	38.2	34.5	25.6	23.6		20.5		15.3	
26	46.5	34.5	30.7	22.6	20.8	14.7	18.0	12.1	12.7	8.1
40	33.8	29.2	24.6	18.0	16.2	11.8	13.4	9.7	9.3	6.2
50	22.8	23.7	20.8	15.9	13.7	10.4	11.3	8.2	7.6	5.1
60	15.5	16.1	16.5	14.2	11.7	9.1	9.4	7.1	6.2	4.4
64	13.1	13.7	14.1	13.6	11.1	8.7	8.9	6.7	5.7	4.1
76	7.5	7.9	8.5	9.0	9.3	7.6	7.3	5.8	4.6	3.4
83	5.0	5.2	5.9	6.3	6.8	7.1	6.6	5.4	4.0	3.1
90			3.8	3.9	4.7	5.0	5.0	5.1	3.6	2.9
93					3.8	4.1	4.1	4.5	3.4	2.8
98					2.5	2.6	2.8	3.0	3.2	2.7

Carbody counterweight: 52.6 t with 1500 mm flat track pads

Rear counterweight:

120.5 t 140.9 t 150.9 t

TLT 13630772 / 306561. Above load charts are for reference only. For actual lift duty please refer to load chart in operator's cabin or manual. Otherwise we recommend you to plan your lifting job using Crane Planner 2.0.

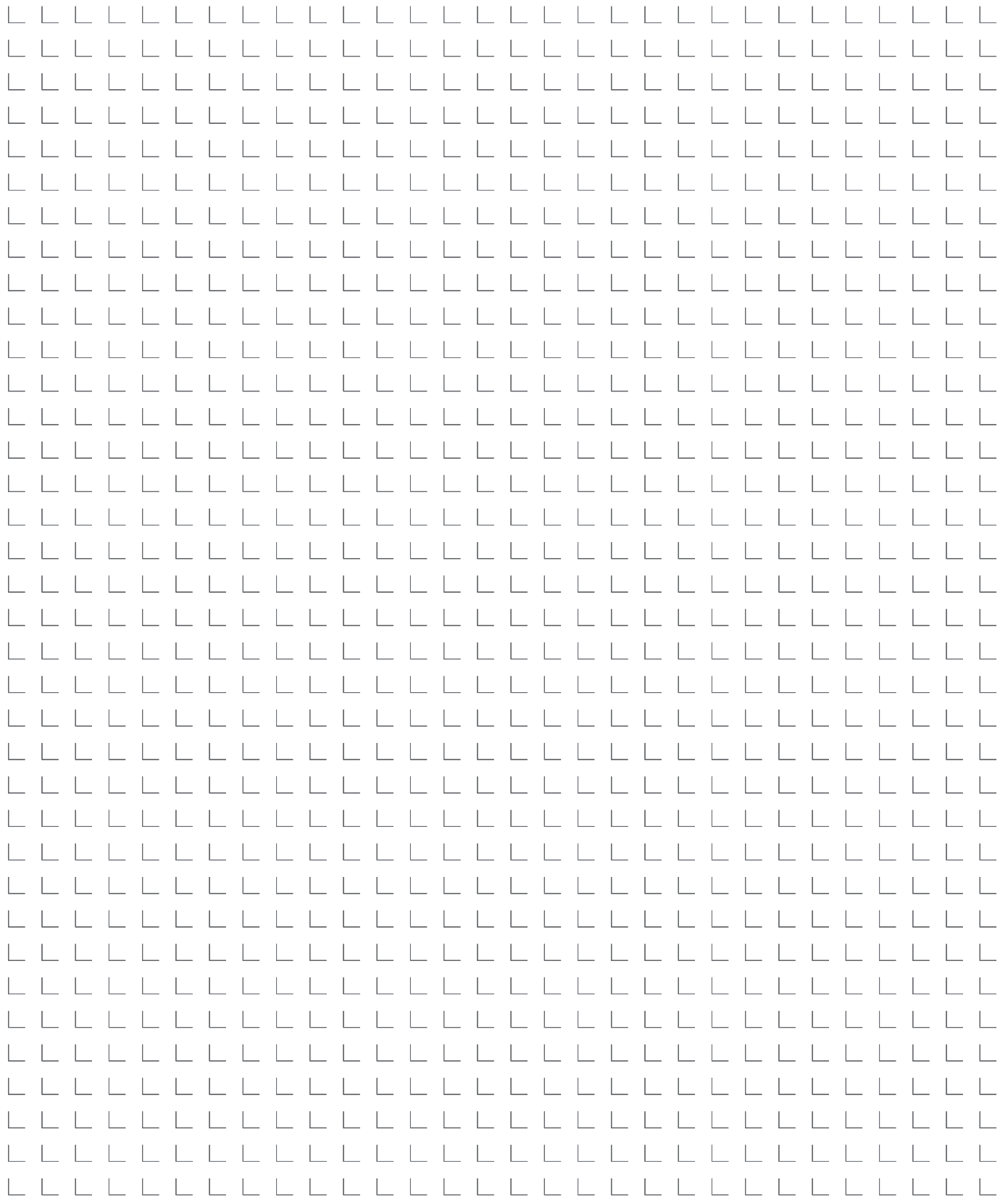



Download datasheet



Please contact us.

Liebherr-Werk Nenzing GmbH · Dr. Hans Liebherr Str. 1 · 6710 Nenzing, Austria
Phone +43 50809 41-473 · crawler.crane@liebherr.com · www.liebherr.com
facebook.com/LiebherrConstruction