

EN

LSC 8-20

AZ 0110.01.03, AZ 0110.62.03
www.liebherr.com

LIEBHERR

Slurry wall cutters

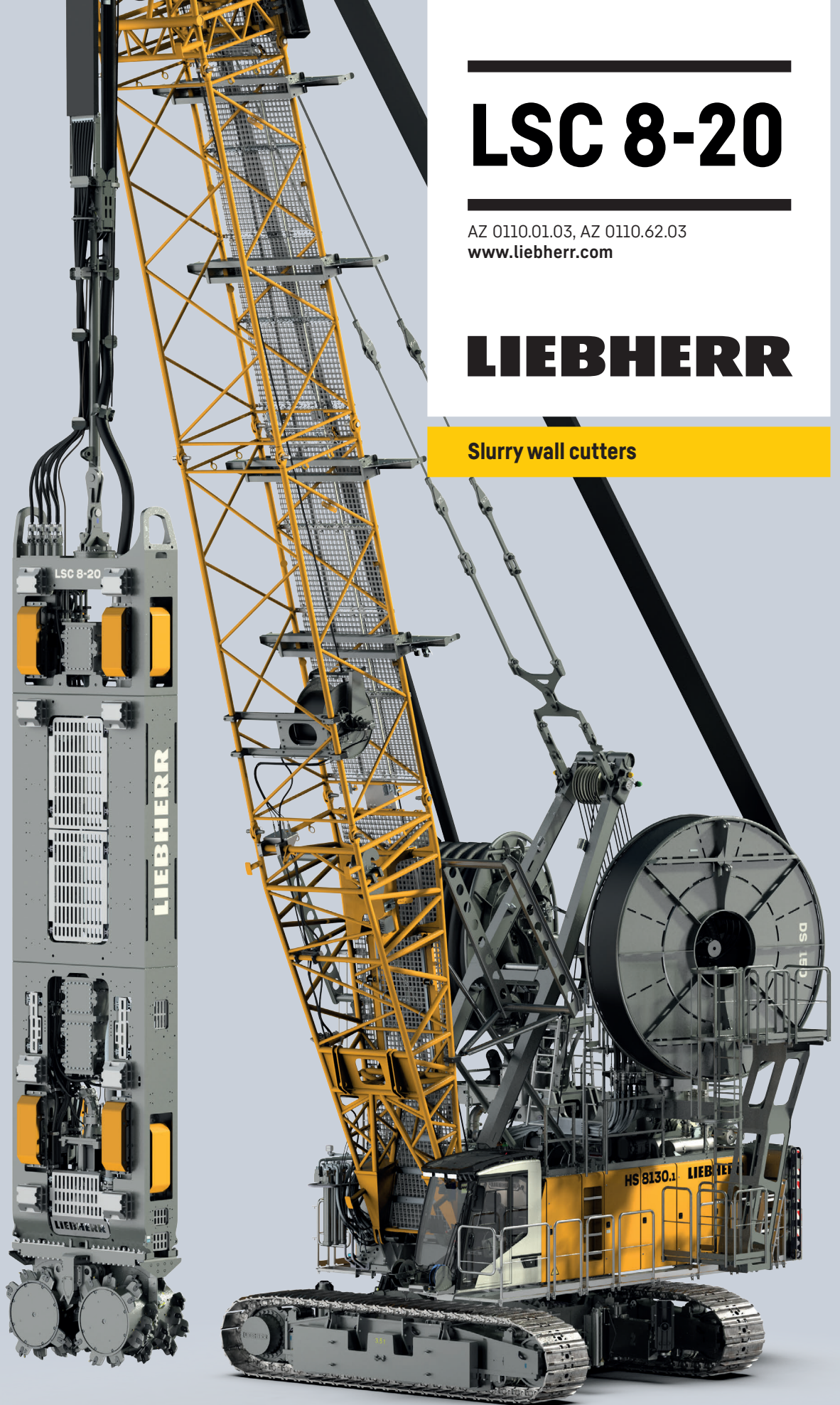

Concept and characteristics

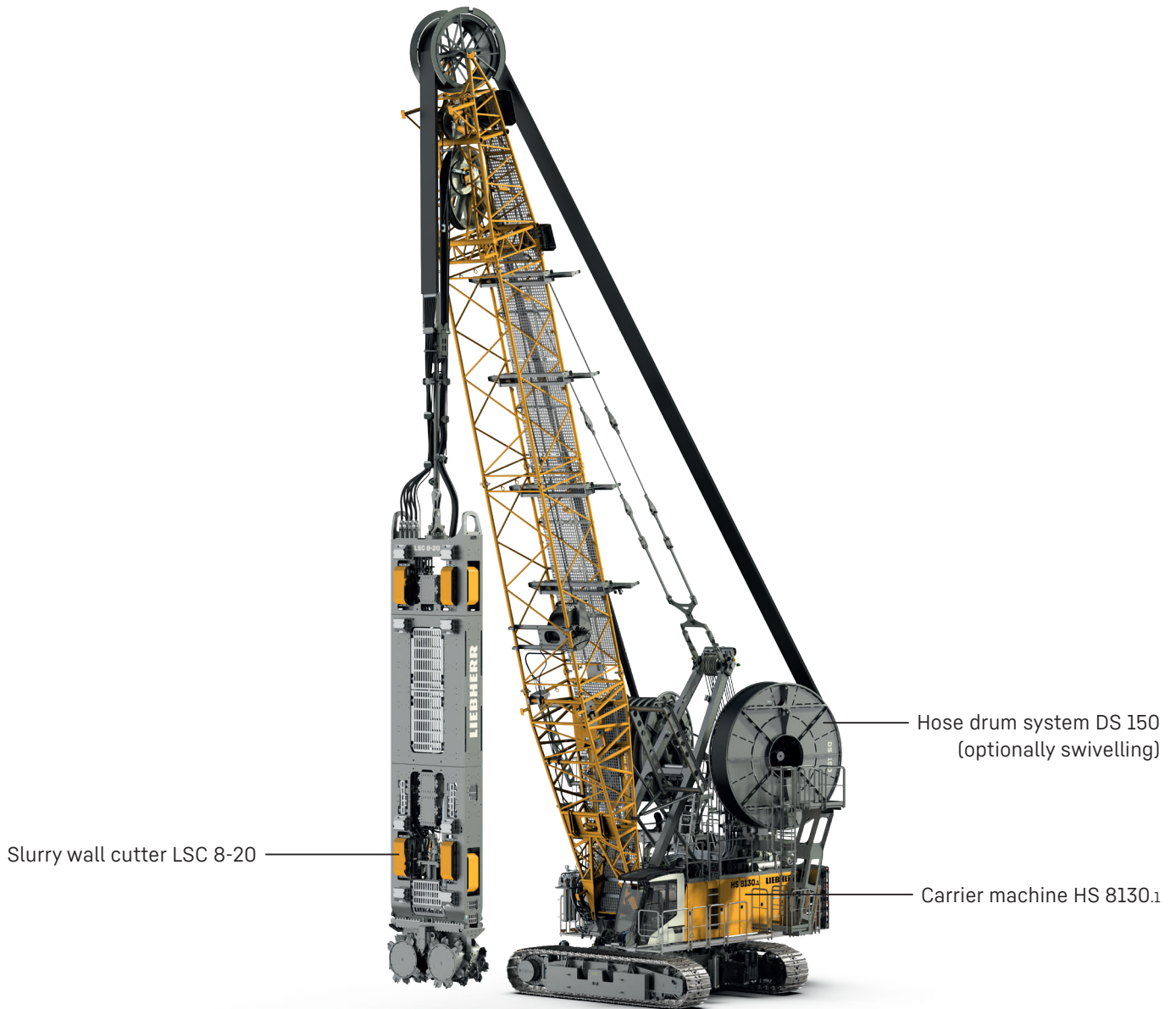

Designed for the demands of urban areas

- Vibration-free slurry wall installation – excavation through cutting
- Slurry walls with depths down to 150 m
- Complicated geometric wall forms – cutter turning device
- Adaptation to various wall dimensions – modular cutter design
- Low space requirements – no additional power pack required
- Low exhaust emission due to an efficient drive system and engine complying with Stage V
- Low noise emission – optional eco-silent mode

Universal carrier machine HS 8130.1 – for diverse deep foundation applications

- Hydraulic / mechanical slurry wall grab
- Spherical grab with casing oscillator (up to Ø3.5 m)
- Lifting operation and material handling grab

Slurry wall cutter LSC 8-20

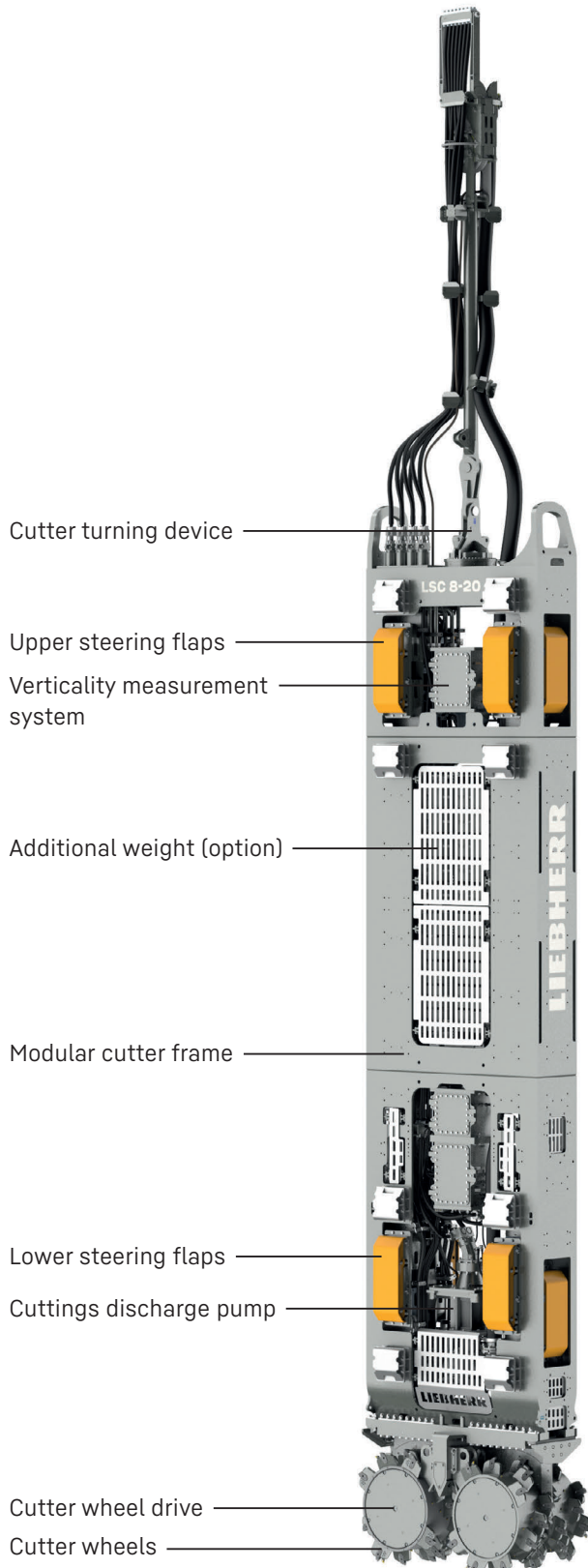

Cutter turning device

- Enables continuous hydraulic turning of the cutter. Thus, all possible working positions are covered entirely.

Lower and upper steering flaps

- 12 independently controllable steering flaps enable correction of the cutting direction.
- The actual position of the flaps is displayed on the operator's monitor in real time.
- Central lubrication system allows for quick and easy lubrication.

Verticality measurement system

- Integrated assistance system supports and records the cutting process.
- Slurry wall deviations along the X and Y axes as well as the rotation round the Z axis are measured.

Modular cutter frame

- The modular cutter frame can be adapted to suit special requirements on the jobsite, thus offering highest flexibility.

Cuttings discharge pump

- Generously designed pump leads to increased efficiency and service life.
- Focus lies on ease of assembly and service.

Cutter wheel drive

- High torque for toughest construction tasks.
- Focus lies on maximum service life of the gearbox and utmost ease of assembly.

Cutter wheels

- Different types are available for different ground conditions.
- The innovative form lock ensures quick and easy exchange of the wheel sets.

Dimensions

Standard

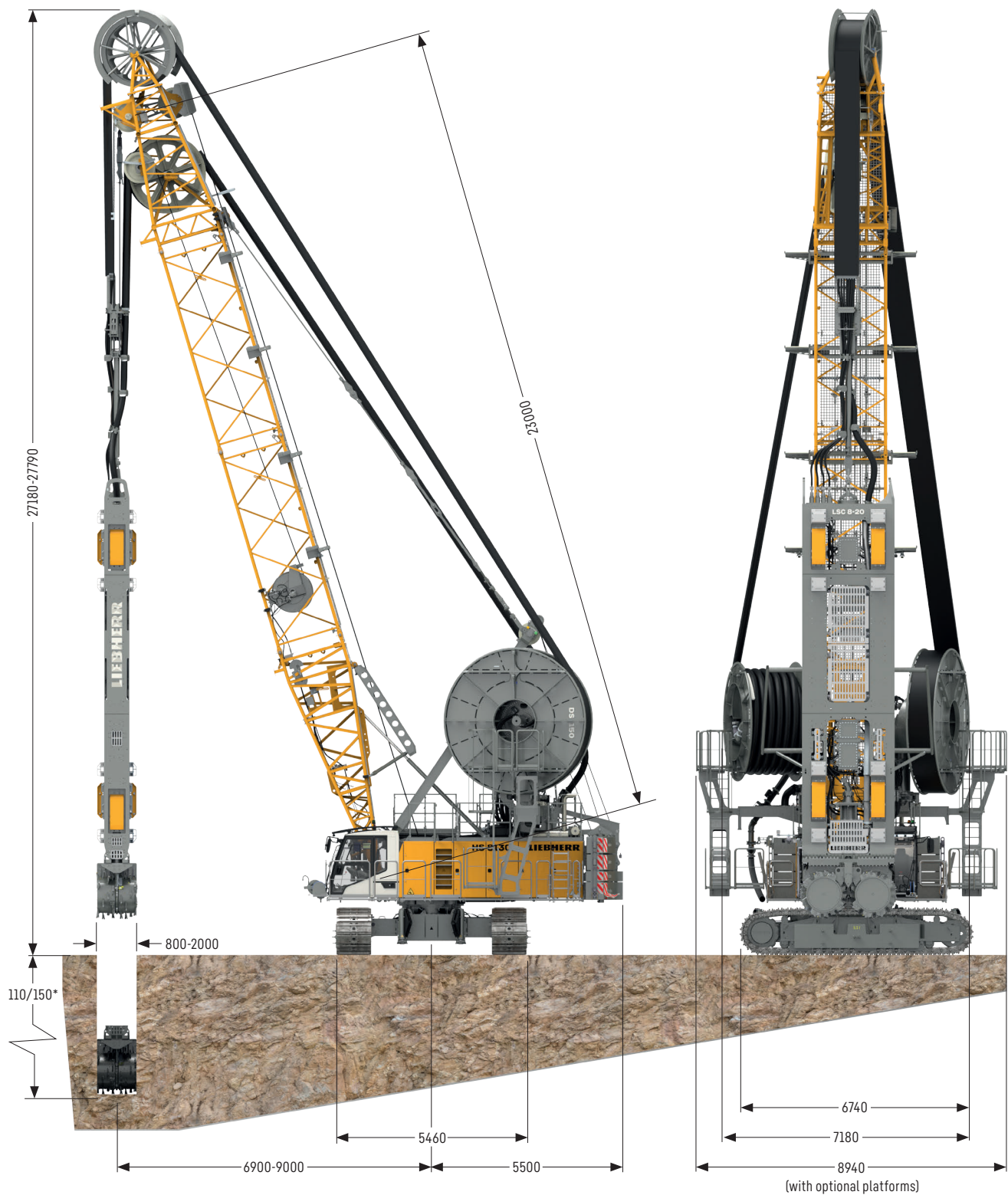

* with optional crowd winch

Low Head

Main boom configuration

Boom section	Amount of boom sections			
	Low Head			Standard
Boom foot 7m	1	1	1	1
Boom section 3m	1	0	1	0
Boom section 6m	0	1	1	2
Boom head 4m	1	1	1	1
Boom length [m]	14	17	20	23

0 - not installed
1 - installed

Rotation limited to +/- 15° when using the C cutter turning device

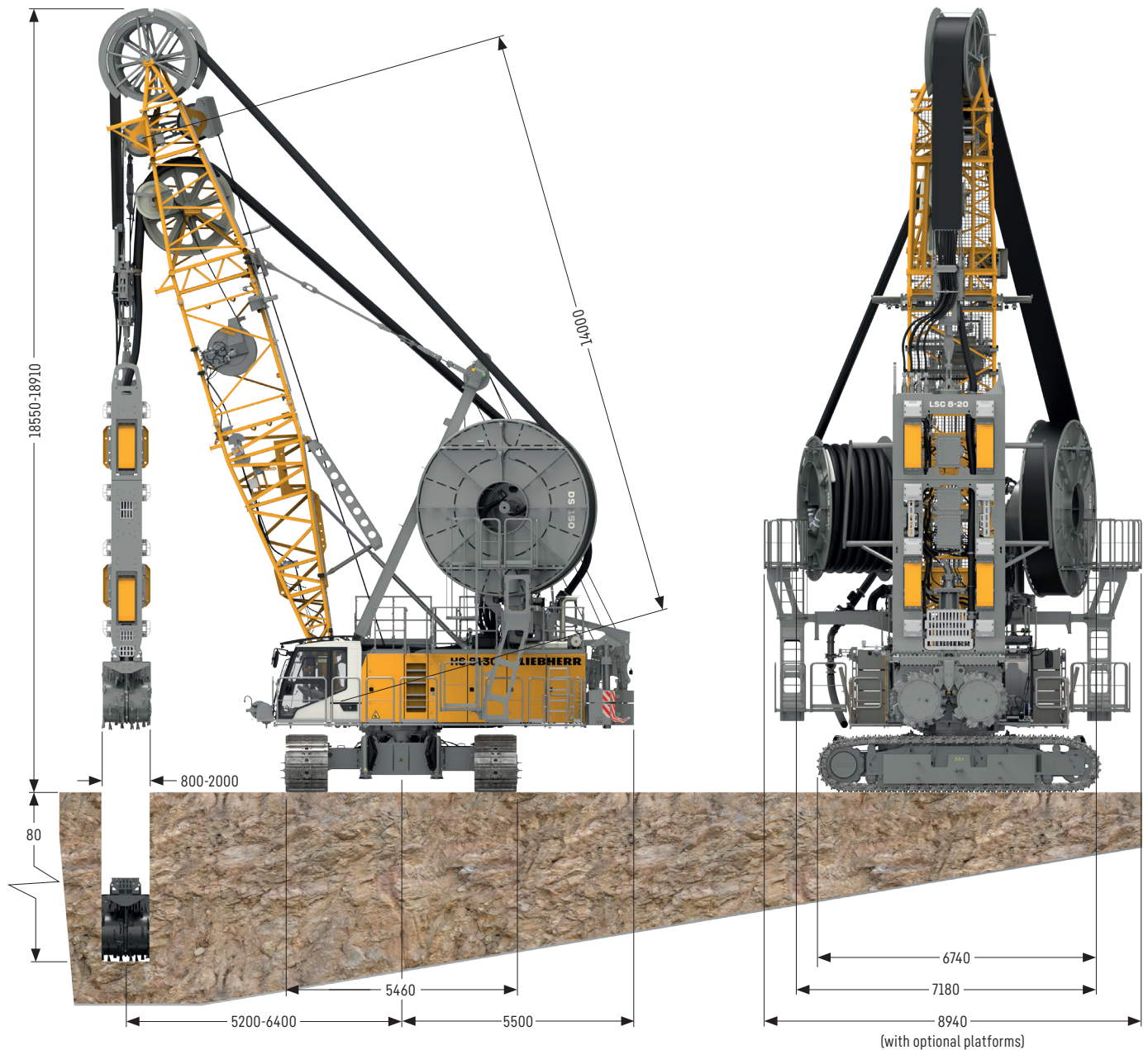
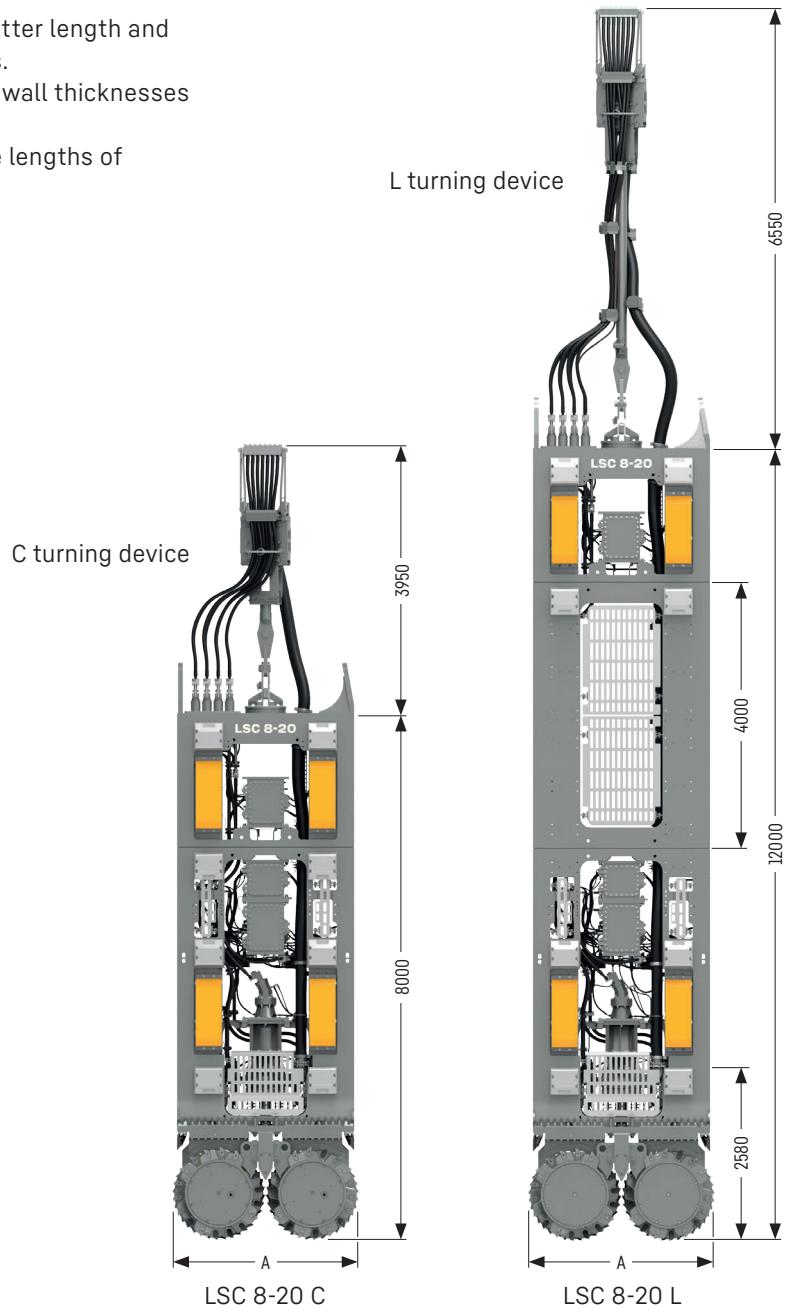

Illustration shows shortest possible version. Intermediate lengths are possible (see page 10).

Modular cutter frame

- Using a removable cutter frame extension the cutter length and weight can be adapted to suit the circumstances.
- The cutter can be adapted for all common slurry wall thicknesses with little effort.
- The same cutter wheel drive can be used for bite lengths of 2800 mm and 3200 mm.



LSC 8-20 C

Bite length (A) [mm]	2800						3200				
Slurry wall thickness [mm]	800	1000	1200	1500	1800	2000	800	1000	1200	1500	1800
Weight [t]	32	34	35	36	38	38	34	35	37	38	39

LSC 8-20 L

Bite length (A) [mm]	2800						3200				
Slurry wall thickness [mm]	800	1000	1200	1500	1800	2000	800	1000	1200	1500	1800
Weight [t] without additional weight	38	40	41	42	43	44	40	41	43	44	45

The given values are guidelines and can vary with the final configuration of the machine.

2000 mm cutting width is only approved for a bite length of 2800 mm, in combination with the standard cutter wheels and without additional weight.

Widening concept

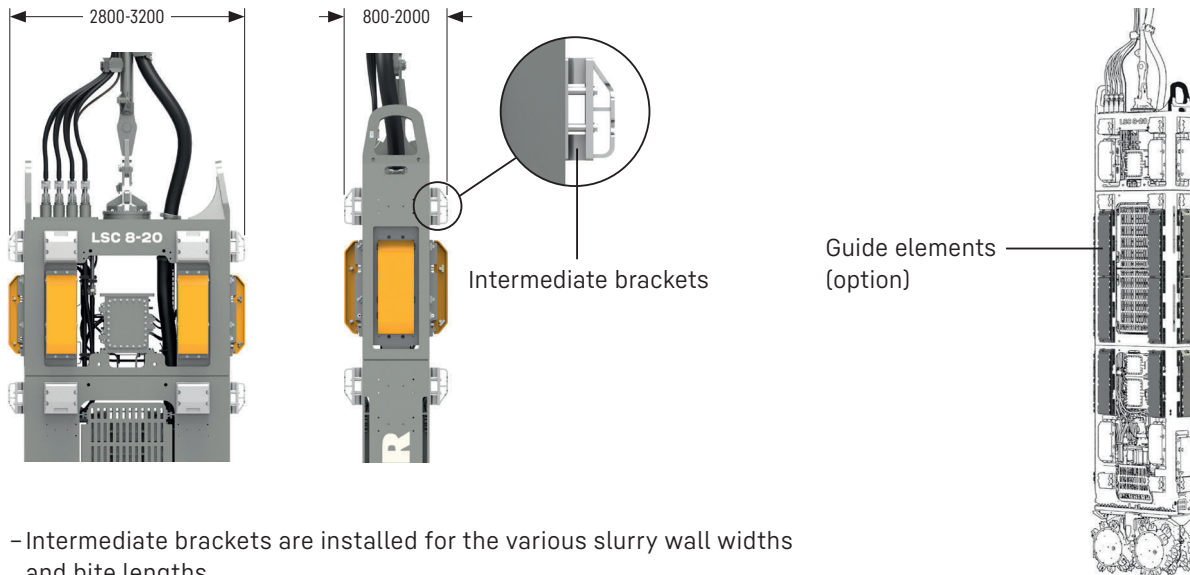

- Intermediate brackets are installed for the various slurry wall widths and bite lengths.
- Additional guide elements can also be fitted as an option.

Additional protective grids (option)

As an option, the cutter can be fitted with protective grids in the upper and lower sections for additional protection.

These additional protective grids can be installed from a slurry wall thickness of 1000 mm.

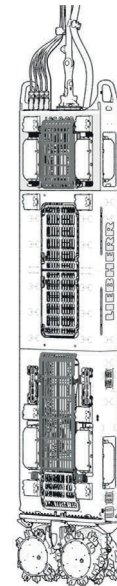

Additional weight (option)

To increase the cutting performance in certain soils, the cutter can be fitted modularly with a maximum weight of 8.3 t.

The modular weight system consists of individual elements weighing 740 kg each.

The maximum permissible total weight of the cutter is 53 t.

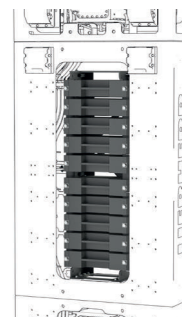

Hose drum system DS 150

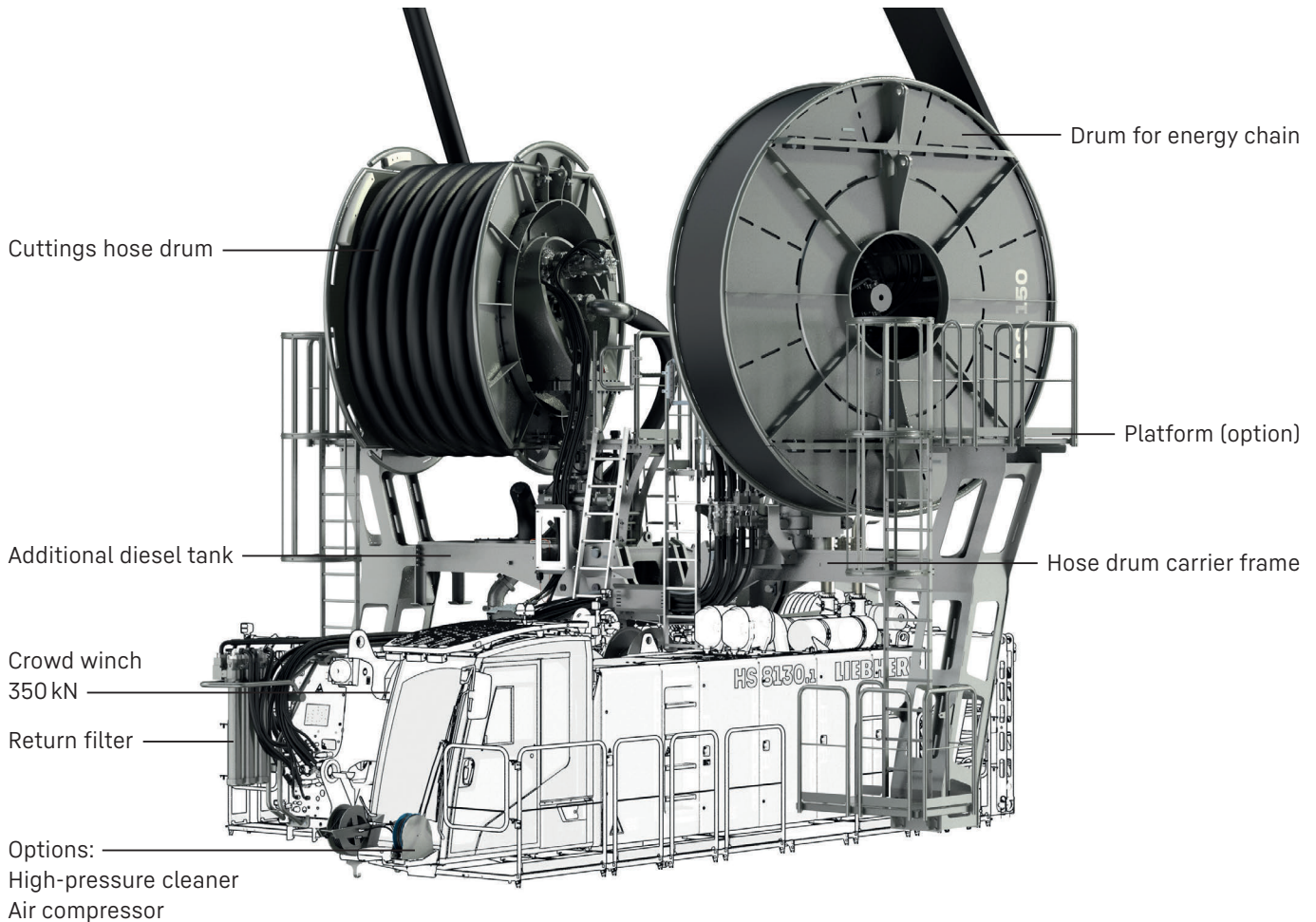

Crowd winch

- One of the two standard free-fall winches (350 kN) is used as a crowd winch.
- The special winch control enables especially high precision when lowering the cutter.
- Continuous adjustment for crowd force and winch speeds

Additional diesel tank

- An additional 500-litre diesel tank increases the total capacity to 1270l.
- This enables longest possible self-sufficient operation.

Return filter

- The hydraulic oil flowing back from the cutter is fed through filters to protect the hydraulic system of the carrier machine from contamination.

Hose drum carrier frame

- Enables quick and easy mounting and dismounting of the cutter carrier
- Excellent access to all important components

Drums for cuttings hose and energy chain

- Optimised for maximum service life of the hoses
- Efficiency is increased through the large diameter of the hoses.

Optional platforms

- These enable quick and safe access to the drums from both sides.
- Easily retrofitted

Special boom head

- Designed for cutting operation with cutter turning device

Swivelling device hose drums (option)



- Improves handling during assembly and disassembly
- Swivelling of the drums and manual lowering/lifting of the cutter can be operated either from the cabin or via the radio remote control.
- Improves the winding up of the cuttings hose during cutting operation, especially at greater depths of up to 150 m
- Adjustability of the drums enables ideal set-up for shorter boom lengths, e.g. Low Head.

Radio remote control

- Easier assembly and disassembly
- Safe movements thanks to better visibility of collision points
- Safe maintenance: special operating mode for replacing cutter teeth and ropes (all other functions are disabled)



Technical description

Carrier machine HS 8130.1 8005.01.03

Engine power	Liebherr V8 Stage V / Tier 4f	570 kW
Diesel tank capacity		770 l + 500 l =1270 l
Hydraulic oil tank capacity		1170 l
Hoist winch 1 cutter		350 kN (free-fall winch)
Hoist winch 2	option	350 kN (free-fall winch)
Rope diameter		36 mm
Usable rope capacity	per winch	232 m

Hose drum system DS 150

Max. working depth		80 m / 110 m /150 m*
Cutter turning device	continuous, hydraulic	-50° to +95°
Energy chain		20 m sections
Cuttings discharge line		40m sections
Total swivelling range energy side		24 °
Total swivelling range cuttings side		15 °

* with optional crowd winch

Slurry wall cutter LSC 8-20

Length of cutter body (C / L)	with / without intermediate section	8 m / 12m
Bite length		2800 mm, 3200 mm
Wall thickness		800, 1000, 1200, 1500, 1800, 2000 mm
Flap control (option)	50 mm lift	12 pcs. (with position indicator)
Cuttings discharge pump max. capacity	152 mm (6")	see head curve (page 14)
Torque of cutter wheel drive		147 kNm
Rotational speed of cutter wheel drive	continuous	0-28.5 rpm
Min. depth of initial excavation		3000 mm

Liebherr slurry wall cutter package (LSC 8-20 1500 x 2800)

Operating weight (carrier machine + hose drum system + cutter)	approx. 190t
Operating weight (carrier machine + hose drum system without cutter)	approx. 150t
Ground pressure of standard undercarriage with cutter	1.7kg/cm ²

Configuration options

Lengths of energy chain, cuttings hose and rope depending on working depth and boom length

LSC L + L turning device 23 m (total height 27.75 m)

	Working depth [m]																											
	20	25	30	35	40	45	50	55	60	65	70	75	80	85	90	95	100	105	110	115	120	125	130	135	140	145	150	
Number of energy chains	3			4				5					6				7				8				9			10
Number of cuttings hoses	2			2				3					3				4				4				5			5
Rope length 1-winch operation [m]	82	92	102	112	122	132	142	152	162	172	182	192	202	212	222	232	242	252	262									
Rope length 2-winch operation [m]	107	117	127	137	147	157	167	177	187	197	207	217	227	237	247	257	267	277	287	297	307	317	327	337	347	357	367	

LSC L + L turning device 20 m (total height 24.8 m)

	Working depth [m]													
	20	25	30	35	40	45	50	55	60	65	70	75	80	
Number of energy chains		3					4					5		6
Number of cuttings hoses		2				2				3			3	
Rope length 1-winch operation [m]	73	83	93	103	113	123	133	143	153	163	173	183	193	

LSC C + L turning device 17 m (total height 21.86 m)

	Working depth [m]													
	20	25	30	35	40	45	50	55	60	65	70	75	80	
Number of energy chains		3				4				5			6	
Number of cuttings hoses		2			2				3			3		
Rope length 1-winch operation [m]	72	82	92	102	112	122	132	142	152	162	172	182	192	

LSC C + C turning device 14 m (total height 18.91 m)

	Working depth [m]													
	20	25	30	35	40	45	50	55	60	65	70	75	80	
Number of energy chains		3				4				5			6	
Number of cuttings hoses		2			2				3			3		
Rope length 1-winch operation [m]	77	87	97	107	117	127	137	147	157	167	177	187	197	

Control concept

Display performance data and data of the separation plant

Verticality display and control



Display main functions

Integrated control of the transfer pump on the separation plant

Main functions controllable via potentiometer

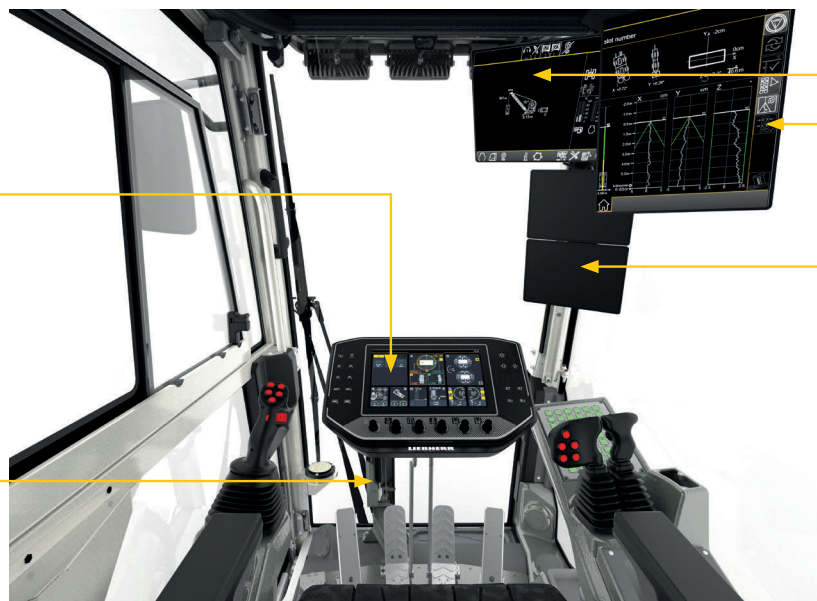

Display carrier machine

Display verticality recording (PDE)

Cutter control panel

Display cameras

Adjustable bracket

- Fully integrated, ergonomic control panel
- All information and control elements relevant for cutting operation on a central control panel
- The position of the control panel can be adjusted to the operator's needs in just a few simple steps.

Cutter drive

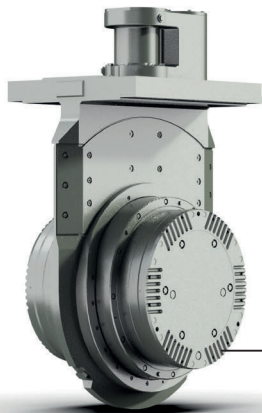

- High torque for toughest applications (147kNm each)
- Focus on max. service life of the gearbox
- Redundant sealing system
- Gearbox with optimised temperature control for toughest assignments
- Quick assembly and disassembly of the cutter wheel drive
- Condition monitoring of gear oil and sealing

Face gearing

Cutter wheel diagrams HS 8130.1

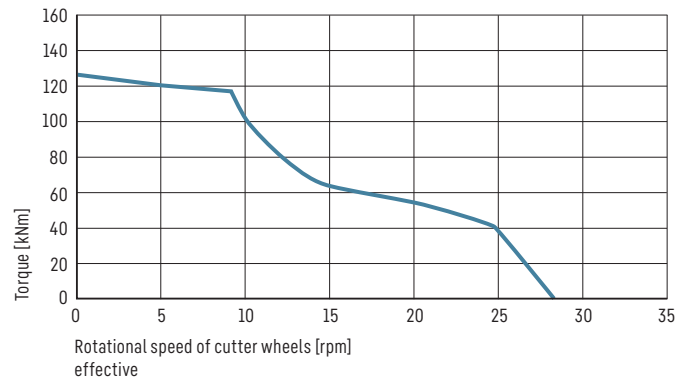
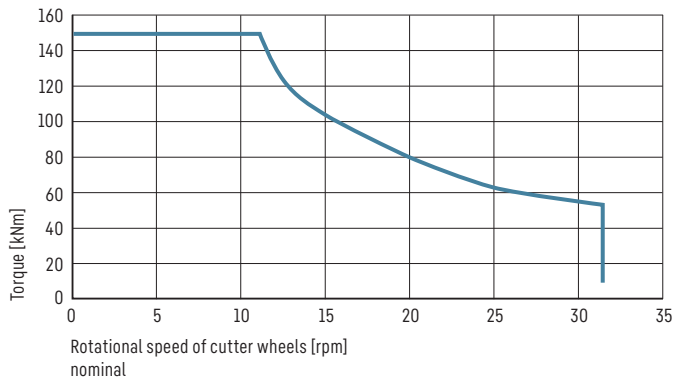

Pay-per-use model – cutter wheel drive

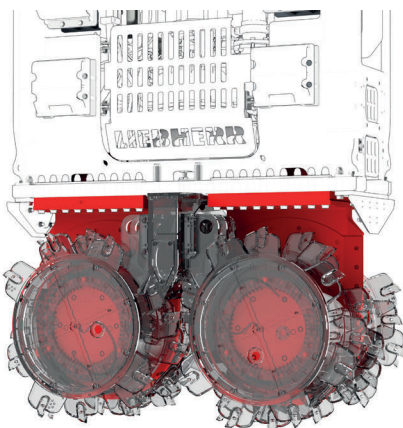

4C-Power

- Gearbox output on an hourly basis
- No unplanned costs
- Usage and utilisation determine the price
- Liebherr takes care of maintenance, availability and performance
- Real-time monitoring of the transmission makes events foreseeable and makes it possible to react at an early stage
- Maximum performance with maximum availability thanks to 4C-Power

Predictive maintenance cutter wheel drive

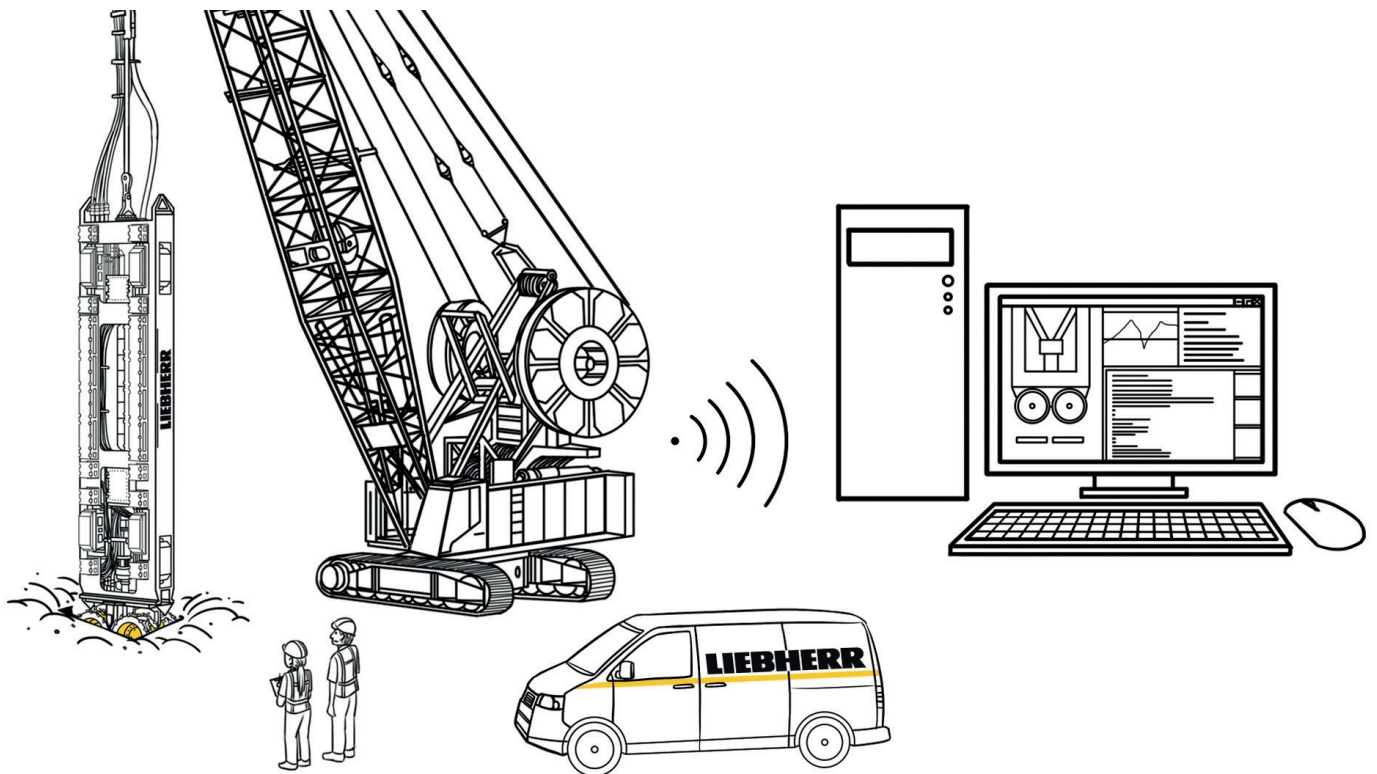

- Continuous monitoring of the condition of the gear oil and seal means that impending malfunctions can be recognised at an early stage. Unplanned downtime is thus reduced and the service life of the gearboxes increased. This means reduced costs and higher availability.
- Both users and Liebherr customer service can monitor the gearboxes remotely and respond in good time.

The integrated oil quality sensor monitors the following gear oil parameters:

- Oil contamination
- Electrical conductivity
- Dielectric constant
- Water saturation
- Oil temperature at the sensor

Cutter wheels

- Large variety of cutter wheels available for the most diverse ground conditions
- Form lock (face gearing) ensures quick and easy exchange of the cutter wheel set
- Cutter wheel covers and scraper plates available as an option

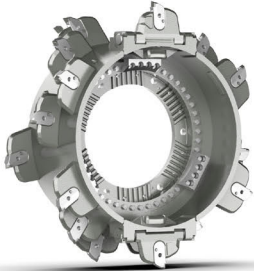

CW-ST
Standard cutter wheel set
 Firm to very stiff cohesive soils as well as loosely to densely consolidated non-cohesive soils with SPT values up to $N_{30} \leq 50$; rock with strengths up to approx. 50 MPa; can be combined with scraper plates.



CW-RO E
Cutter wheel set for rock
 Soft to hard rock with strengths over 50 MPa.

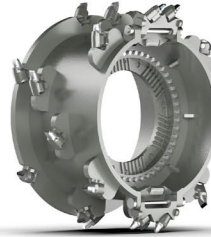

CW-ST E
Cutter wheel set for mixed soils
 Firm to very stiff cohesive soils as well as loosely to densely consolidated non-cohesive soils with SPT values up to $N_{30} \leq 50$; rock with strengths up to approx. 50 MPa.



CW-TR E
Cutter wheel set for non-cohesive soils
 Loosely to densely consolidated non-cohesive soils with SPT values up to $N_{30} \leq 50$; rock with strengths up to approx. 50 MPa.

Cuttings discharge pump

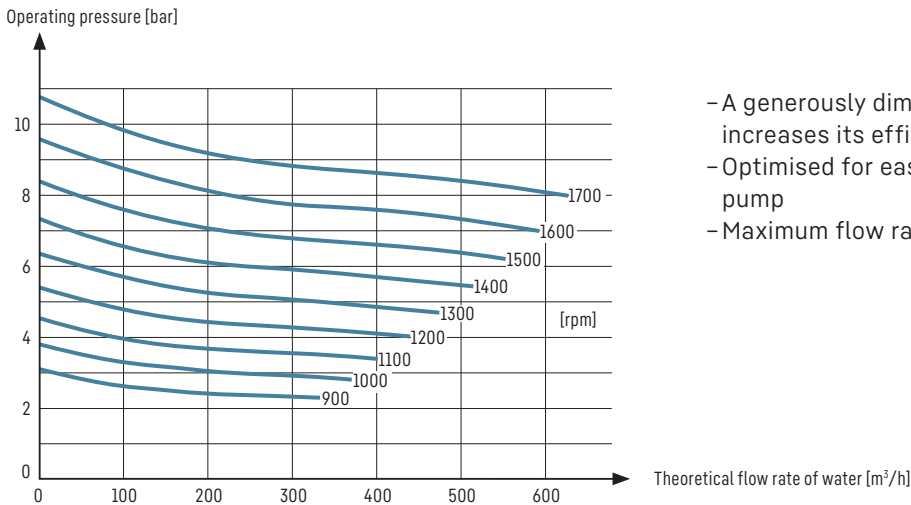

- A generously dimensioned cuttings discharge pump increases its efficiency and service life.
- Optimised for easy replacement and servicing of the pump
- Maximum flow rate 450 m³/h

Turning device

- Continuous hydraulic turning of the cutter from the operator's cabin
- All working positions can be served
- Turning through hydraulic cylinders in the cutter frame
- Maximum turning angle $-50^\circ / +95^\circ$ (for the L turning device)
- Turning angle for the C turning device $\pm 15^\circ$
- Low maintenance: central lubrication for swing ring

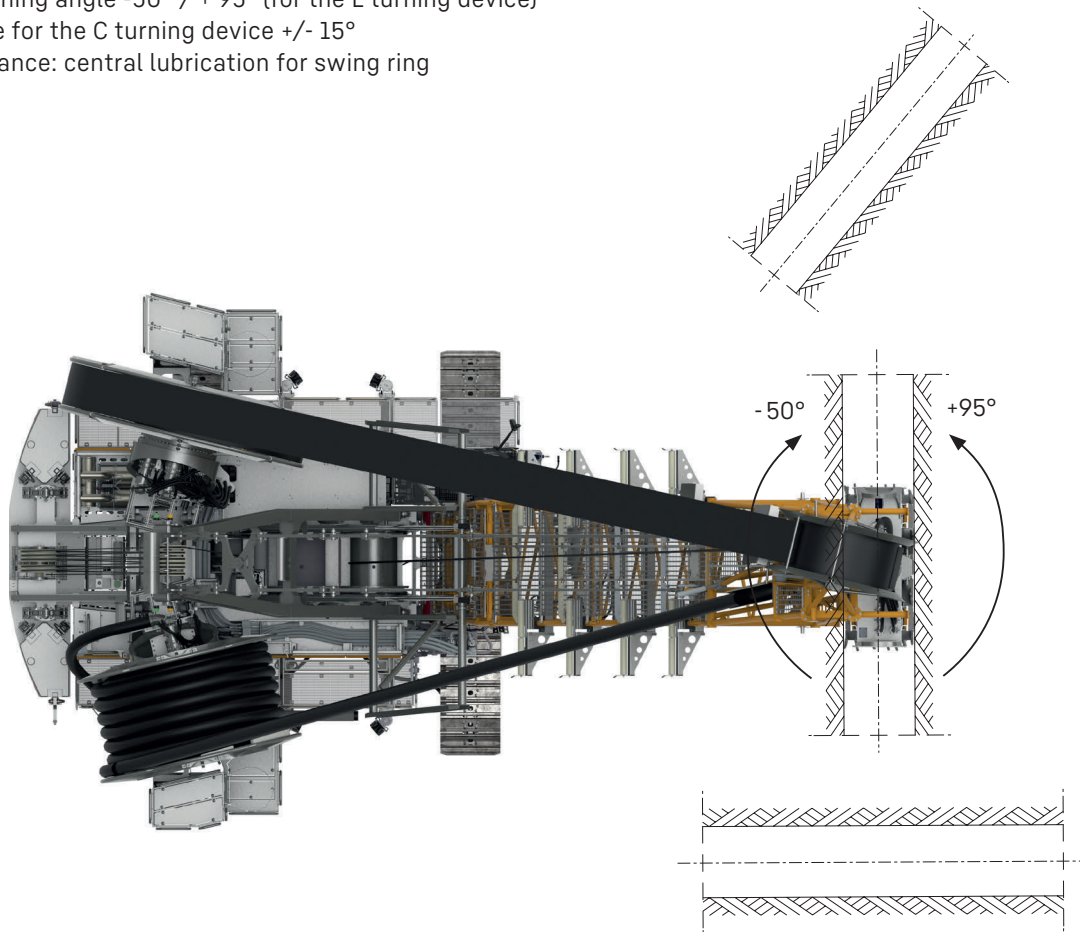

Transport dimensions and weights

Components for slurry wall cutter LSC 8-20

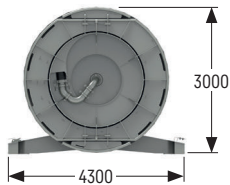
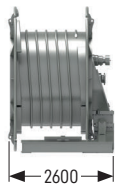

Cuttings hose drum

Weight	t 8.5
1 element cuttings hose (40 m)	t 1.3

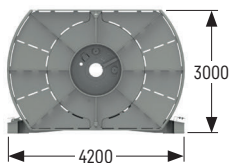

Drum for energy chain

Weight	t 7.7
1 element energy chain (20 m)	t 1.4

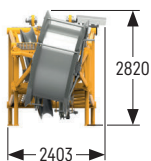
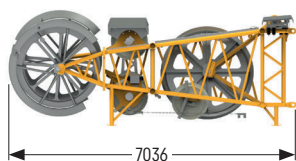

Boom head

Weight	t 6.3
--------	-------

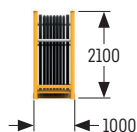
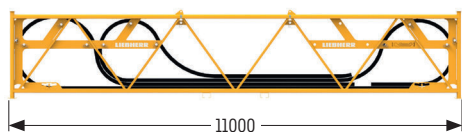

Transport frame for energy chain

Weight incl. 2 energy chains	t 4.6
------------------------------	-------

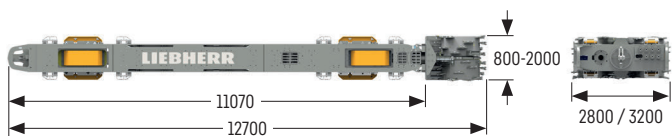

Slurry wall cutter LSC 8-20

Weights see page 6

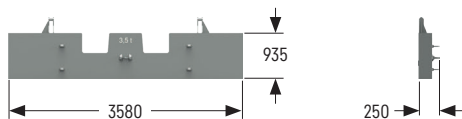
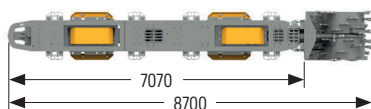

Carbody counterweight (2x)

Weight	t 3.5
--------	-------

Carrier machine HS 8130.1

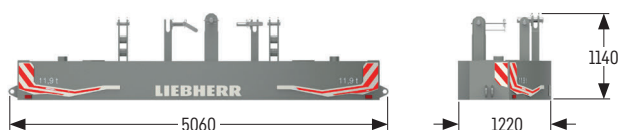
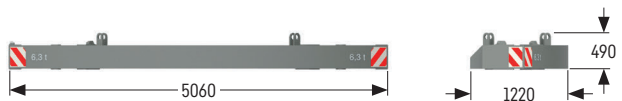
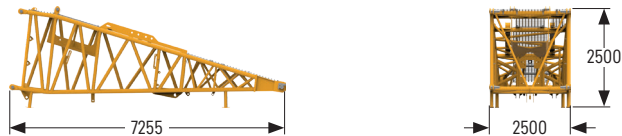
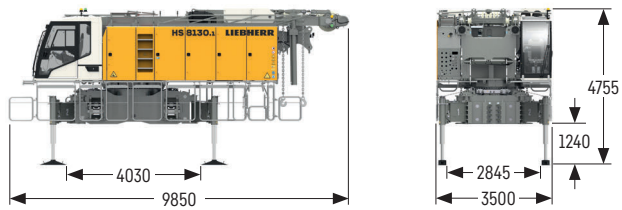
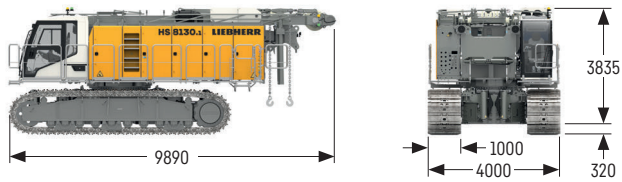

Basic machine

with HD undercarriage, A-frame, 2x 350kN winches and self-assembly system for basic counterweight, without boom foot and basic counterweight - fully tanked and ready for operation

Width	mm	4000
Weight without hoist ropes	kg	78000
Weight of hoist ropes (2x 90 m)	kg/m	6455

Basic machine

with A-frame, 2x 350kN winches and self-assembly system, without boom foot, basic counterweight and crawlers - fully tanked and ready for operation

Width	mm	3500
Weight without hoist ropes	kg	51000
Weight of hoist ropes (2x 90 m)	kg/m	6455

Crawler (2x)

Weight	kg	14900
--------	----	-------

Boom foot (2018.33)

Weight	kg	3215
--------	----	------

Boom section 3 m (2018.33)

Weight	kg	750
--------	----	-----

Boom section 6 m (2018.33)

Weight	kg	1230
--------	----	------

Counterweight slab (4x)

Weight	kg	2680
--------	----	------

Counterweight slab (1x)

Weight	kg	6300
--------	----	------

Counterweight slab (1x)

Weight	kg	12000
--------	----	-------

Verticality assistant

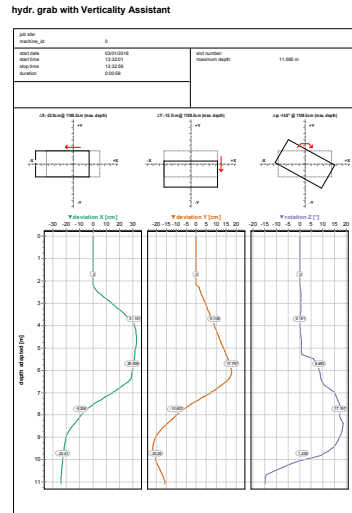
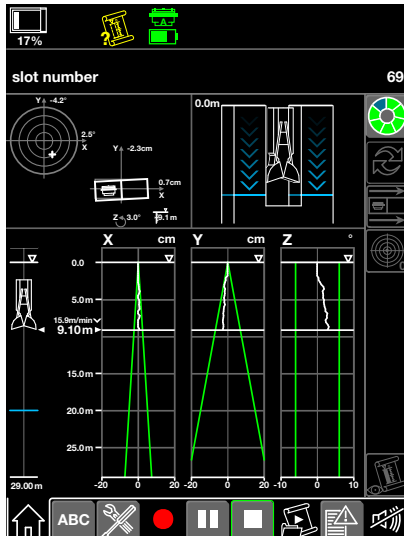

PDE



LiDAT



MyJobsite

Verticality assistant for slurry wall construction

This assistance system is fully integrated in the Liebherr machine's control and process data recording system. It supports and records the slurry wall installation process. With the help of the verticality assistant deviations in the slurry wall along the X and Y axes, as well as the rotation round the Z axis are measured.

- Visualisation of the measurements for the machine operator
- Optimum support for the machine operator through an innovative, graphic control system in order to carry out successful measurements
- Ensures optimum measuring conditions by automatically limiting the hoisting speed with two options (exact slow or accelerated measuring run)
- Simple guidelines for calibrating the verticality measuring system
- Mobile data transfer via the telematics system from the machine to the reporting software in the office (MyJobsite)

This system allows control of the precision for the whole depth of the trench. Reports can also be created in MyJobsite for the whole slurry wall installation process. These enable traceability of the application and proof of quality.



Download datasheet



Please contact us.

Liebherr-Werk Nenzing GmbH · Dr. Hans Liebherr Str. 1 · 6710 Nenzing, Austria
Phone +43 50809 41-473 · crawler.crane@liebherr.com · www.liebherr.com
facebook.com/LiebherrConstruction